

Reaching for the sky with SDSS and LSST

Željko Ivezić

Department of Astronomy
University of Washington

Heidelberg Joint Astronomical Colloquium, June 22, 2010

Sky surveying is experiencing a bonanza as detectors, telescopes and computers become ever more powerful. Using SDSS to illustrate what will be possible with LSST:
data-intensive astronomy

1. **Modern Sky Surveys: Lessons from SDSS**
2. **LSST: the System Parameters and Science Drivers**
3. **Three Science Examples from SDSS**
 - **Solar System Inventory:** main-belt asteroids
 - **Time-domain astronomy:** quasar variability
 - **Milky Way Structure:** mapping with main sequence and RR Lyrae stars

The Era of Massive Optical Surveys

- Currently, the best large-area optical survey is SDSS:
the first digital color map of the sky
- **Lessons from SDSS:** uniform surveys yield diverse and cutting-edge science (>2000 papers from SDSS in <10 years) in a cost-efficient way; public data access leads to democratization and globalization of science

The Era of Massive Optical Surveys

- Currently, the best large-area optical survey is SDSS: **the first digital color map of the sky**
- **Lessons from SDSS:** uniform surveys yield diverse and cutting-edge science (>2000 papers from SDSS in <10 years) in a cost-efficient way; public data access leads to democratization and globalization of science
- **SDSS Legacy:** Many upcoming and proposed optical surveys: Pan-STARRS, SkyMapper, Dark Energy Survey, One-degree Imager, HyperSuprimeCam, Large Synoptic Survey Telescope

The Era of Massive Optical Surveys

- Currently, the best large-area optical survey is SDSS: **the first digital color map of the sky**
- **Lessons from SDSS:** uniform surveys yield diverse and cutting-edge science (>2000 papers from SDSS in <10 years) in a cost-efficient way; public data access leads to democratization and globalization of science
- **SDSS Legacy:** Many upcoming and proposed optical surveys: Pan-STARRS, SkyMapper, Dark Energy Survey, One-degree Imager, HyperSuprimeCam, Large Synoptic Survey Telescope
- **LSST:** about 100 times more surveying power than SDSS

What will LSST do?

the first digital color movie of the sky

SDSS results can be used to “predict” the impact of LSST: three case studies a bit later...

LSST Science Drivers

1. The Fate of the Universe: Dark Energy and Matter
2. Taking an Inventory of the Solar System
3. Exploring the Unknown: Time Domain
4. Deciphering the Past: mapping the Milky Way

Different science drivers lead to similar system requirements
(NEOs, main-sequence stars to 100 kpc, weak lensing, SNe,...):

Main LSST Characteristics:

- 8.4m aperture (6.7m effective), ~ 10 deg² FOV
- 3200 Megapix camera (20 TB, or one SDSS, per night)
- Sited at Cerro Pachon, Chile
- First light in 2016 (Decadal Survey Report 2010!)
- Construction cost: 455 M\$ (public-private partnership)

And also to the same observing strategy (cadence):

a homogeneous dataset will utilize 90% of observing time and serve the majority of science programs (with a high system efficiency)

What is LSST:

an optical/near-IR survey of half the sky in multiple bands (ugrizy) to $r = 27.5$ based on about 1000 visits over a ten-year period:
a catalog of ~ 10 billion stars and ~ 10 billion galaxies with exquisite photometry, astrometry and image quality

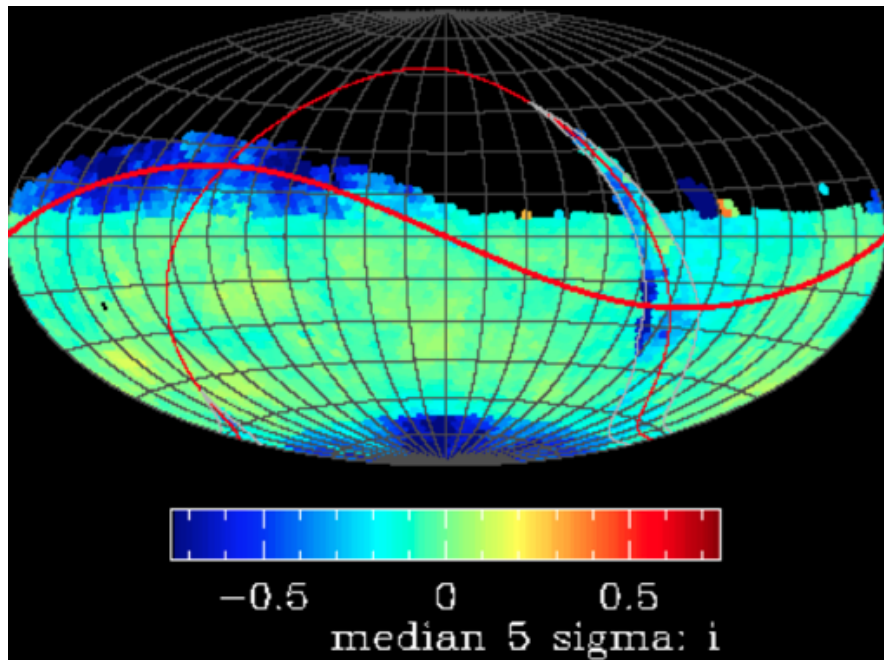

Selected Science Goals

- **Dark Energy and Dark Matter** (**four billion galaxies** with excellent photometry and shape measurements, several million SNe, clusters of galaxies, millions of quasars)
- **The Solar System Map** (140m killer asteroids, several 10^6 main-belt, $\sim 100,000$ trans-Neptunian, Sedna-like to beyond 200 AU)
- **The Transient Universe** (a variety of time scales ranging from ~ 10 sec, to the whole sky every 3 nights, 1000 visits)
- **The Milky Way Map** (main sequence to 100 kpc, RR Lyrae to 400 kpc, geometric parallaxes for all stars within 300 pc)

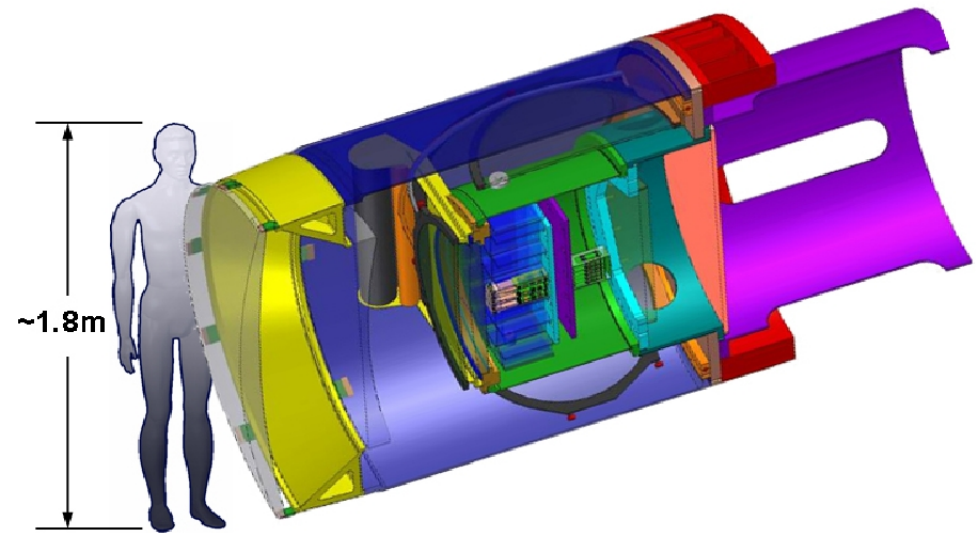
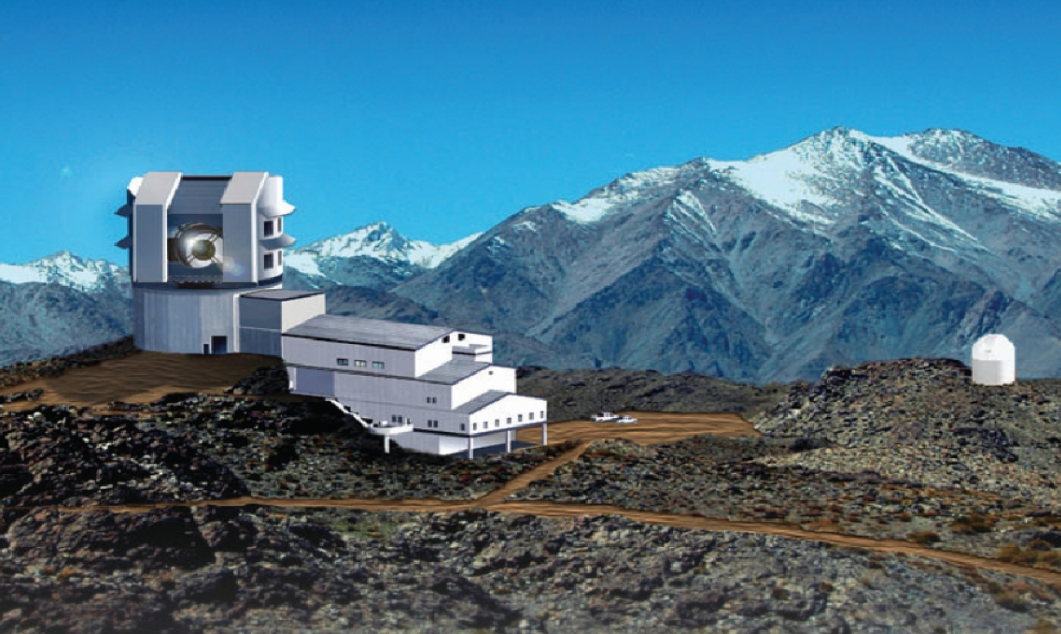

Wavefront Sensors
(4 locations)

Guide Sensors
(8 locations)

3.5 degree Field
of View (634 mm diameter)

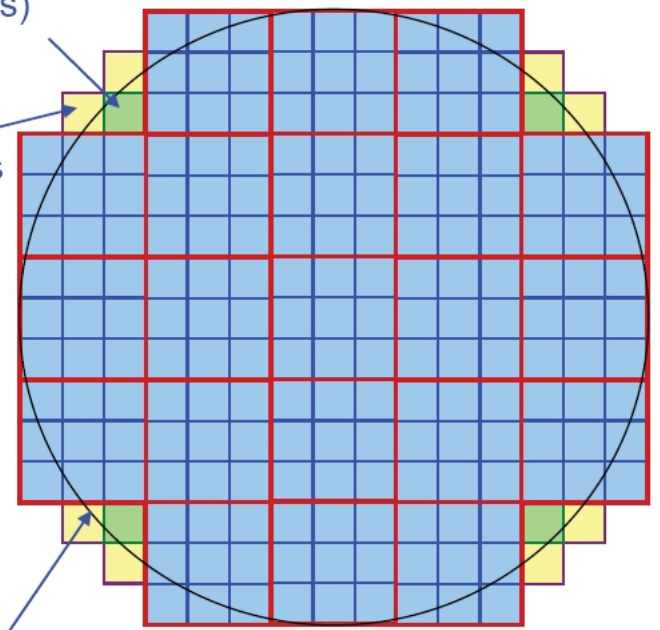
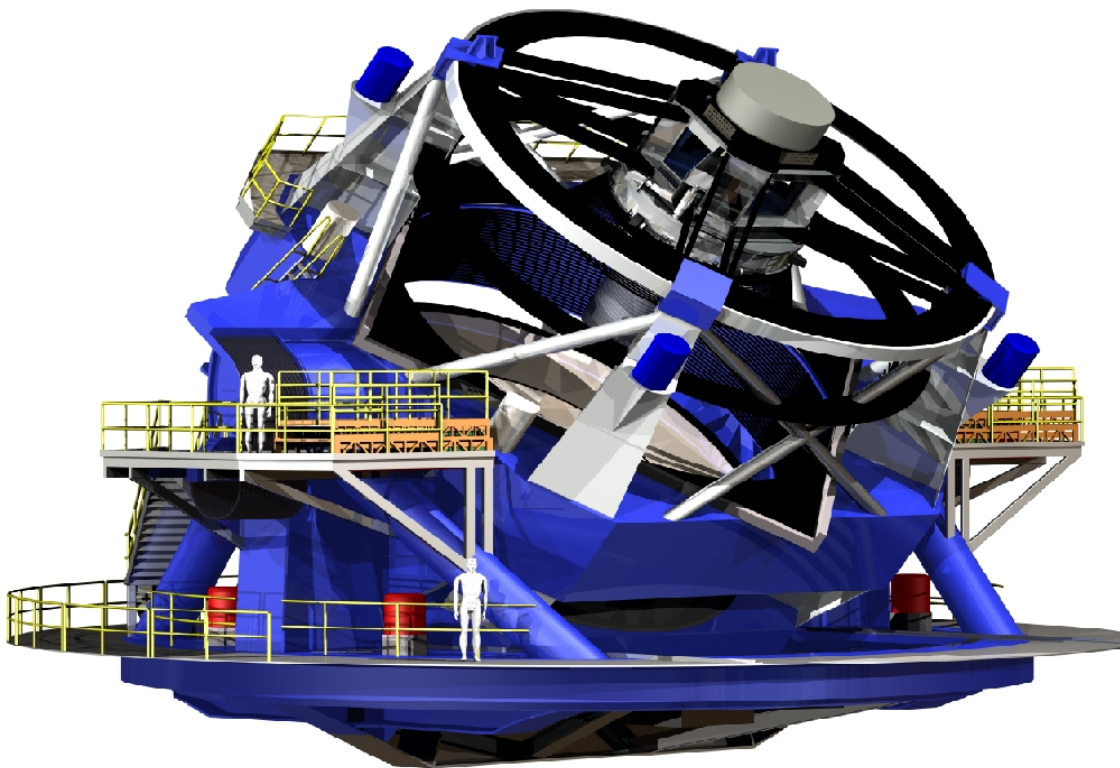

Primary Mirror Diameter

Field of View



Gemini South Telescope

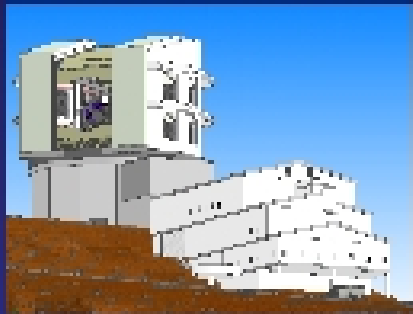
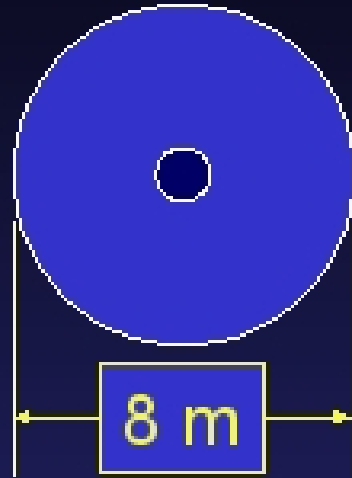

LSST

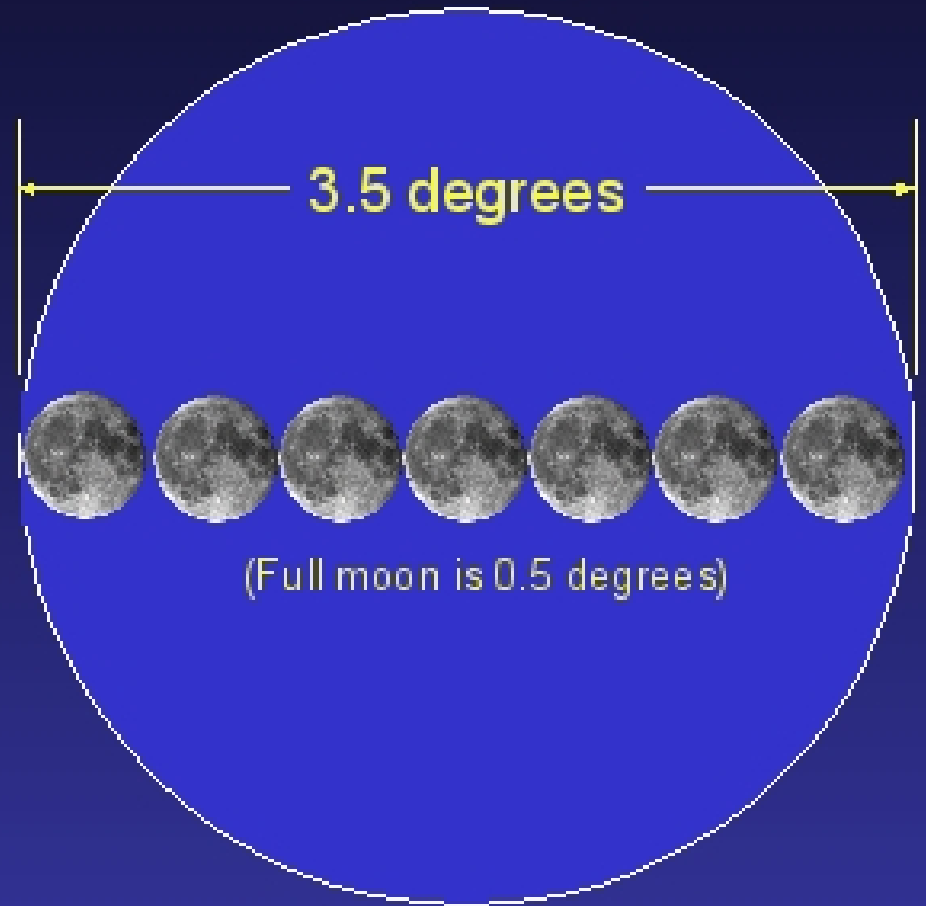
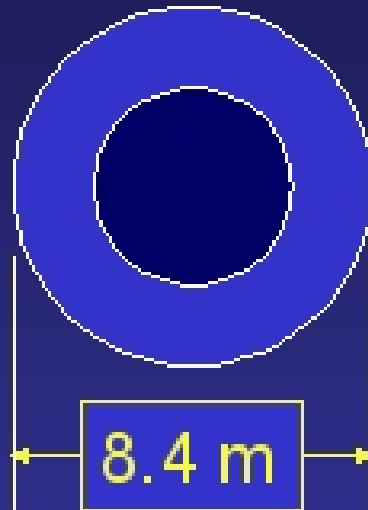

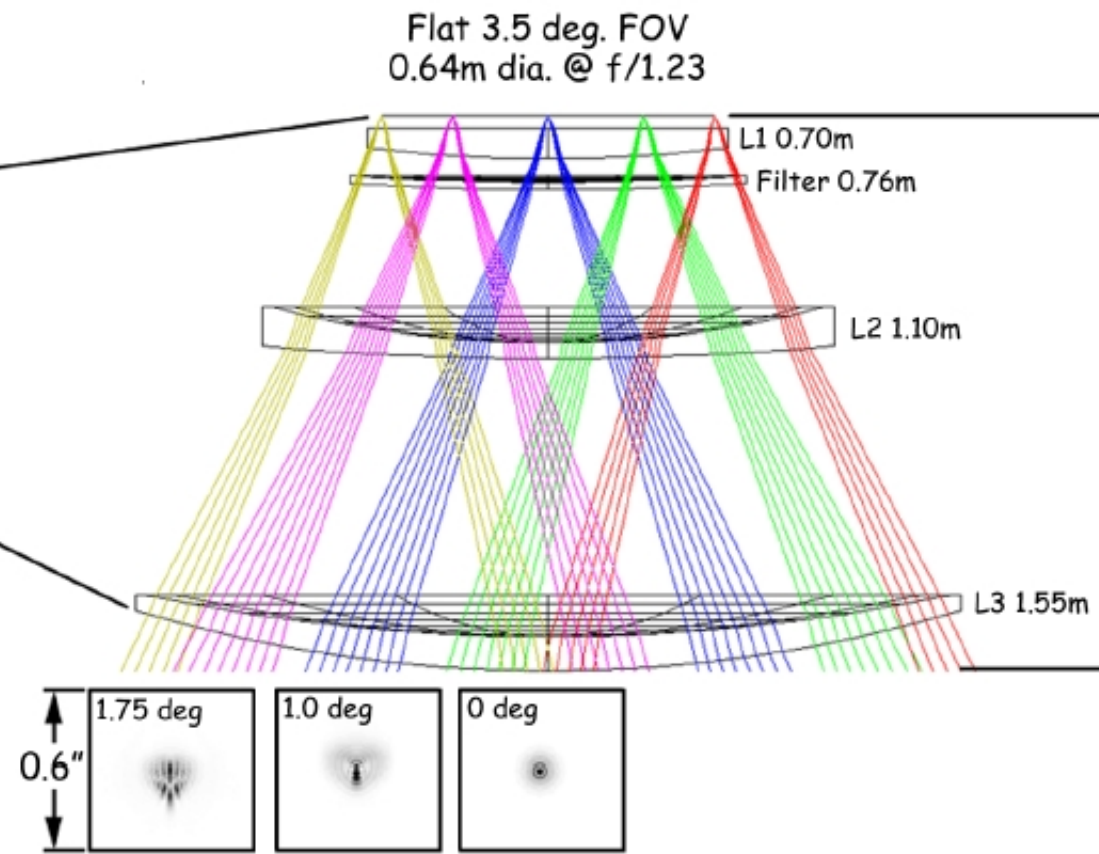
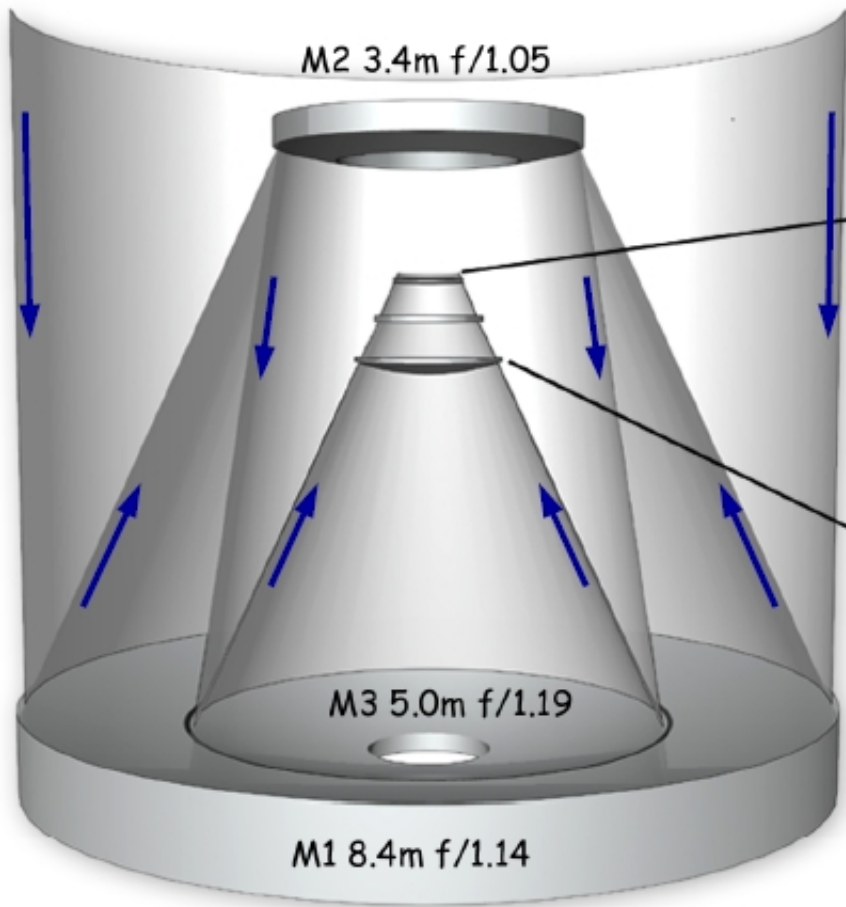



Large Synoptic Survey Telescope

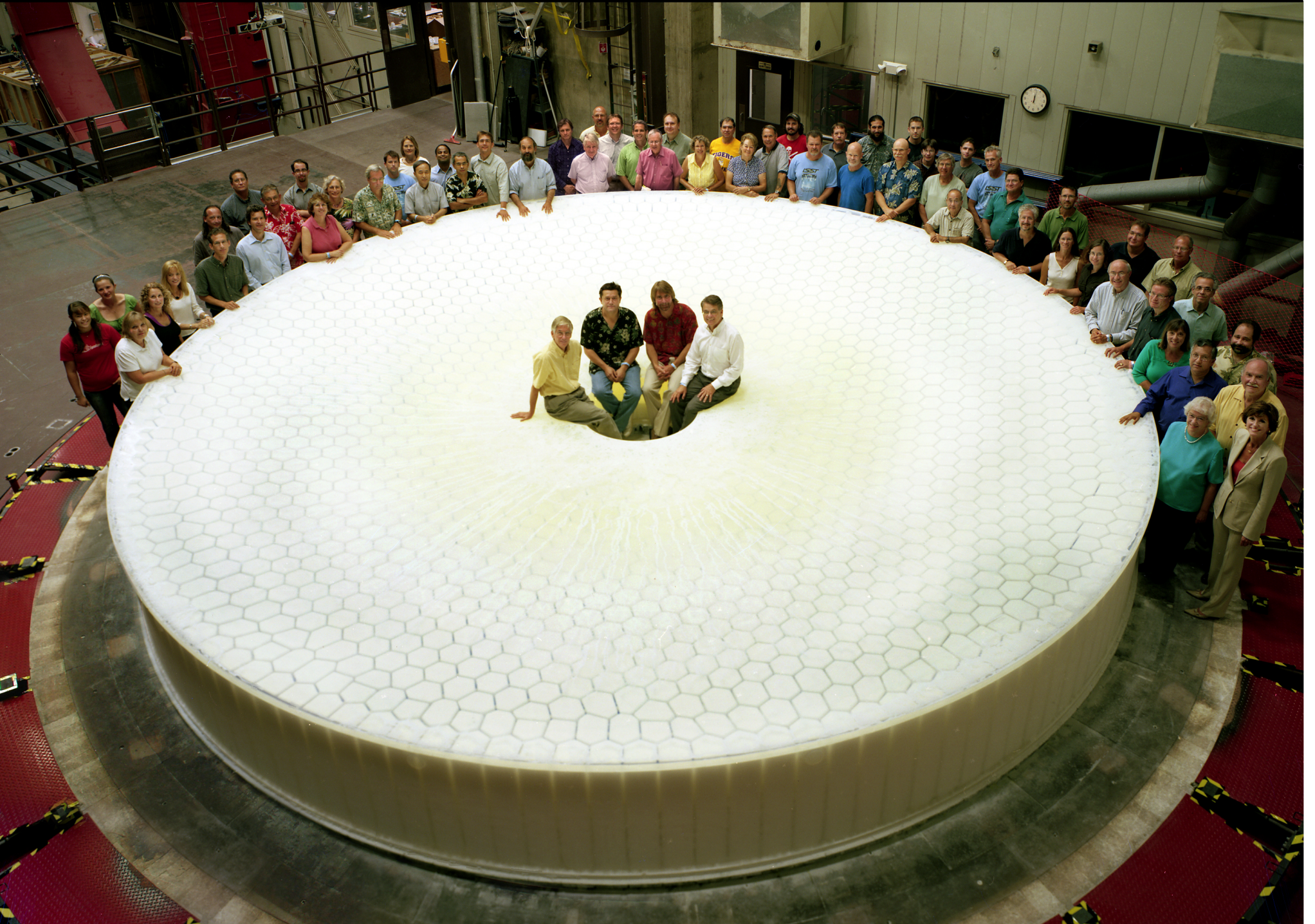

LSST Primary/Tertiary Mirror Blank

August 11, 2008, Steward Observatory Mirror Lab, Tucson, Arizona

LSST vs. SDSS comparison

Currently, the best large-area faint optical survey is

SDSS: the first digital map of the sky

$r \sim 22.5$, 1-2 visits, 300 million objects

- **LSST = d(SDSS)/dt**: an 8.4m telescope with 2x15 sec visits to $r \sim 24.5$ over a 9.6 deg² FOV: the whole (observable) sky in two bands every three nights, **1000 visits over 10 years**
- **LSST = Super-SDSS**: an optical/near-IR survey of the observable sky in multiple bands (ugrizy) to $r > 27.5$ (coadded); a catalog of **~ 10 billion stars and ~ 10 billion galaxies**

LSST: a digital movie of the sky

LSST data will immediately become public

(transients within 60 sec)



SDSS: one US Library of Congress worth of data

LSST: one SDSS per night, or all the words ever printed!

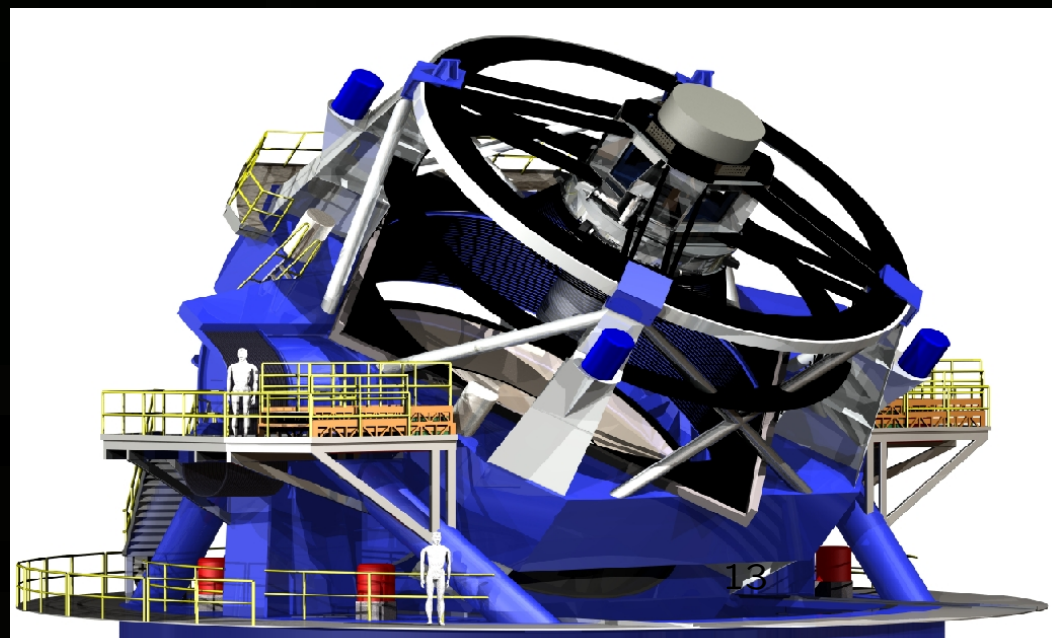
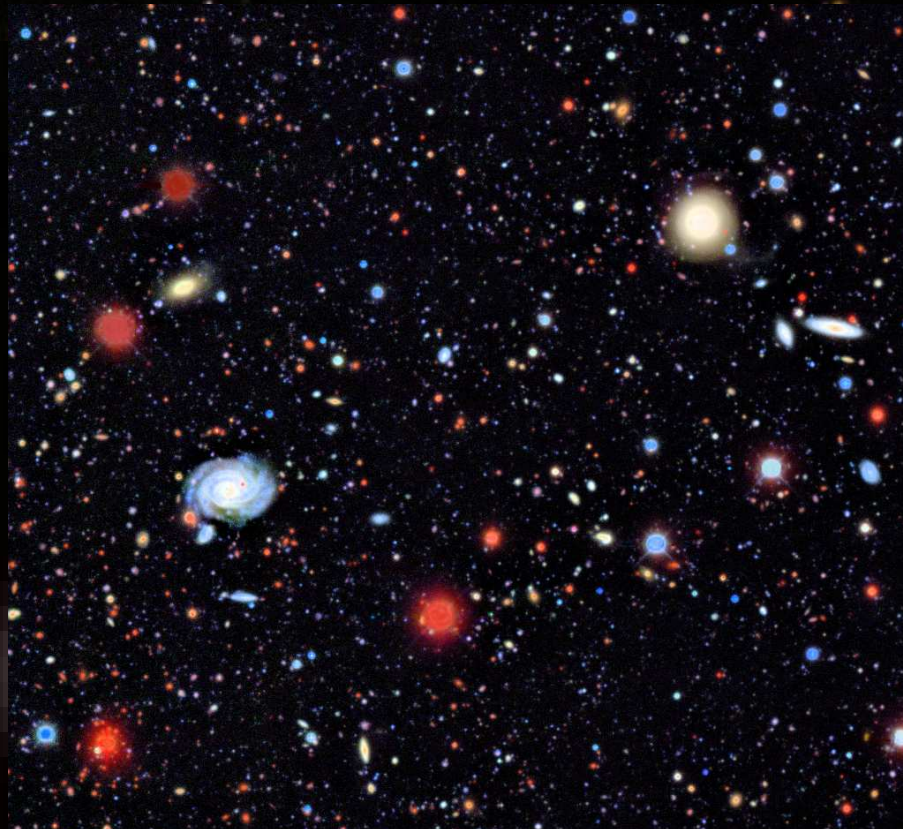

SDSS

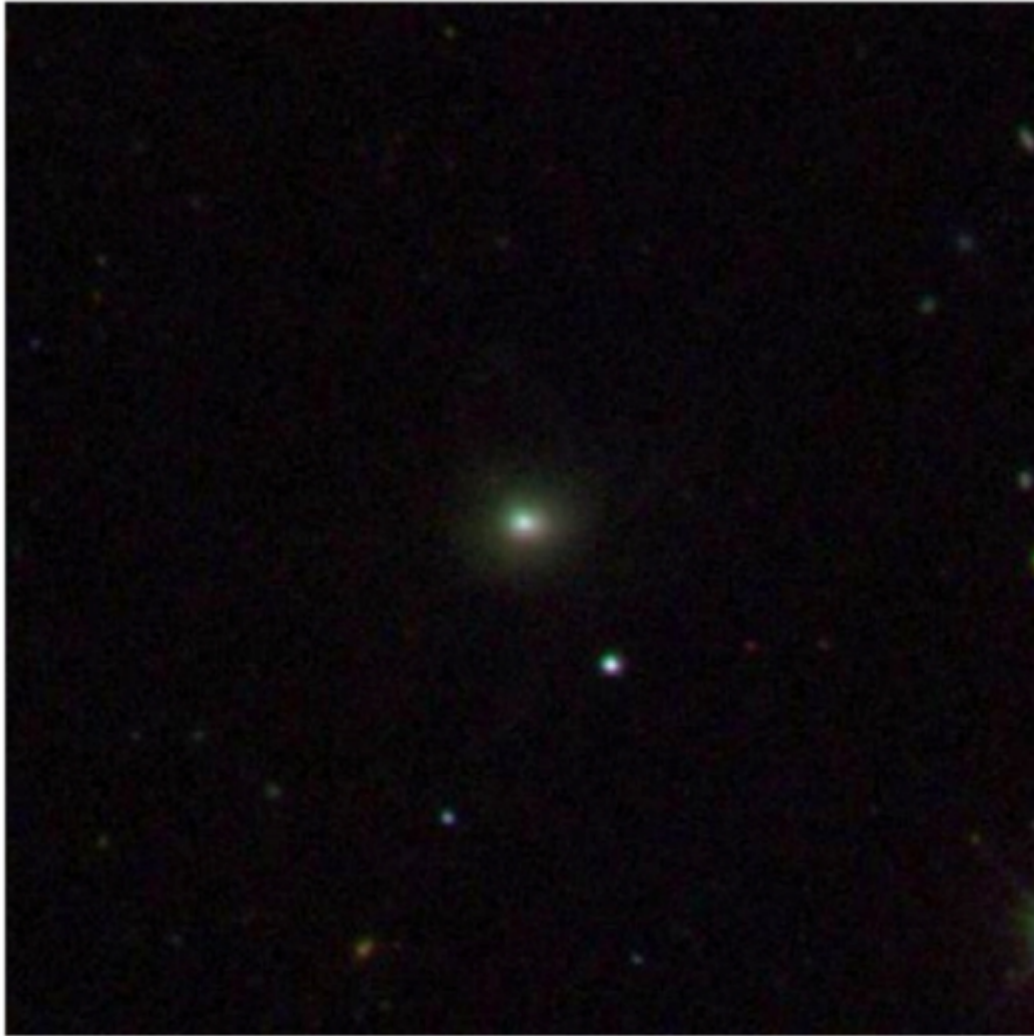

MUSYC



LSST Science Drivers

- The Fate of the Universe (Dark Energy and Matter):
use a variety of probes and techniques in synergy to fundamentally test our cosmological assumptions and gravity theories:
 1. **Weak Lensing:** growth of structure
 2. **Galaxy Clusters:** growth of structure
 3. **Baryon Acoustic Oscillations:** standard ruler
 4. **Supernovae:** standard candle

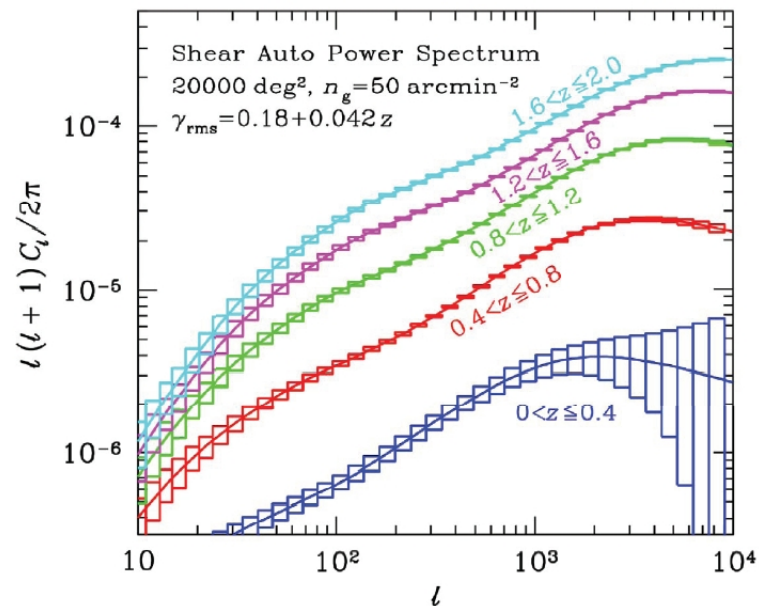
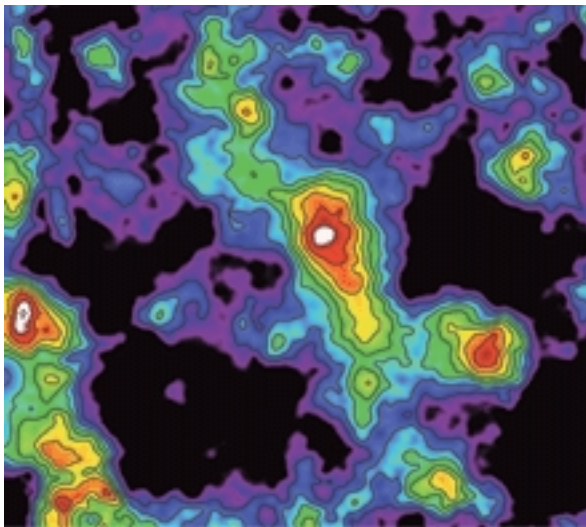

Weak lensing shear power spectrum provides strong constraints on cosmological parameters, dark matter distribution, and even the sum of neutrino masses (to better than 0.04 eV).

CMB

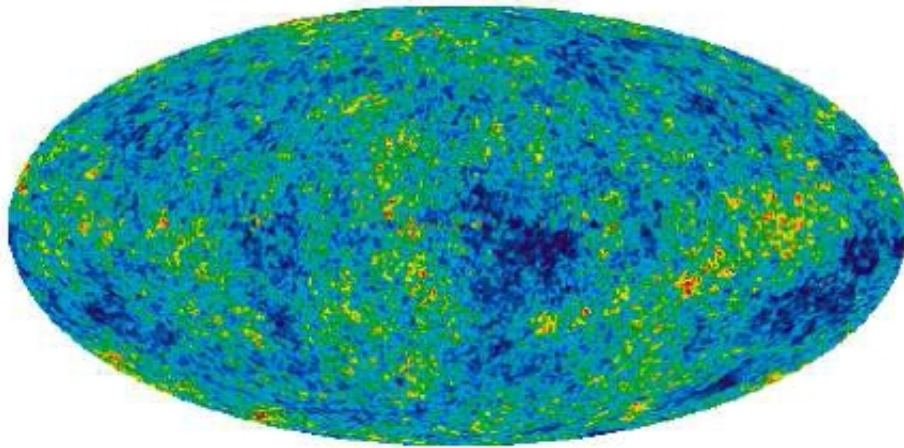

Galaxies

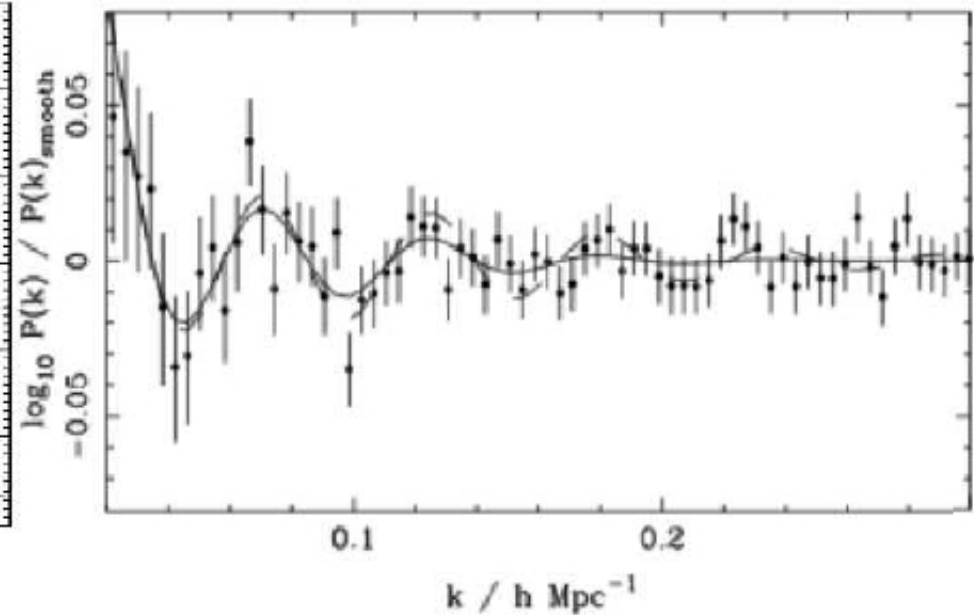
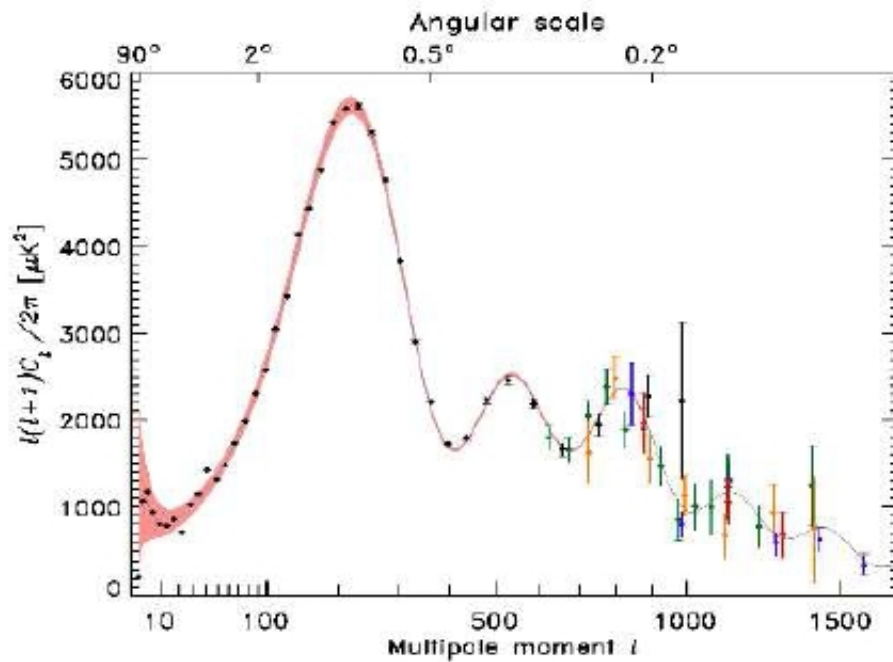
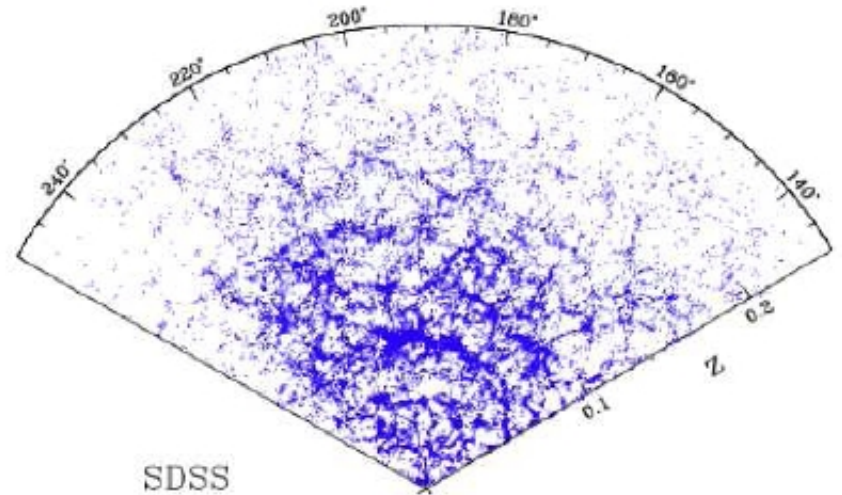

Baryon acoustic oscillations:
standard ruler – a new cosmological tool

Co-moving Distance Measurements with LSST

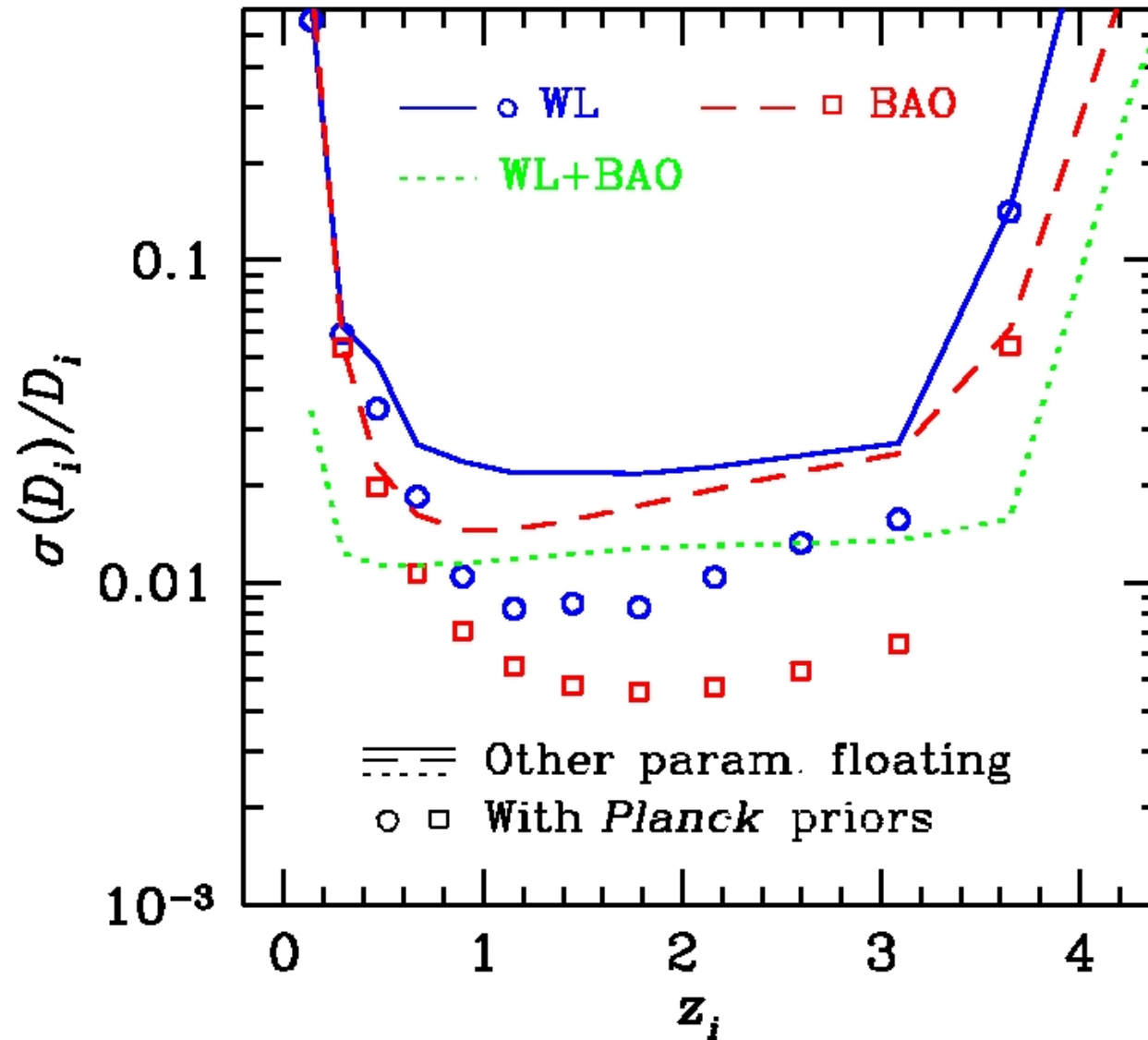

Measuring distances with a percent accuracy for $0.5 < z < 3$

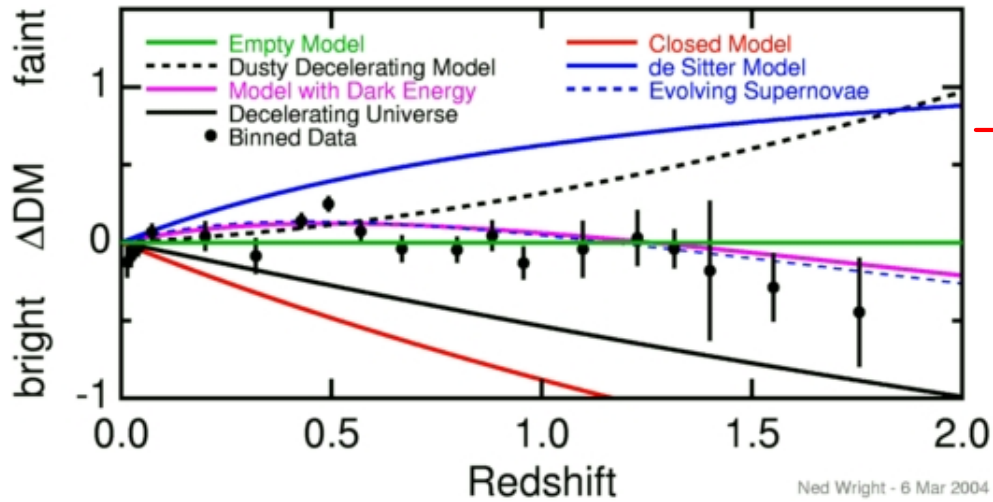

Type Ia Supernovae Cosmology with LSST

- **Type Ia Supernovae:** provide strong support for the existence of dark energy and recent acceleration of the Hubble expansion
- **Systematics:** can be calibrated using WL and BAO
- **LSST SNe:** several million, **the only probe to provide high angular resolution constraints on the homogeneity and isotropy of the Universe**

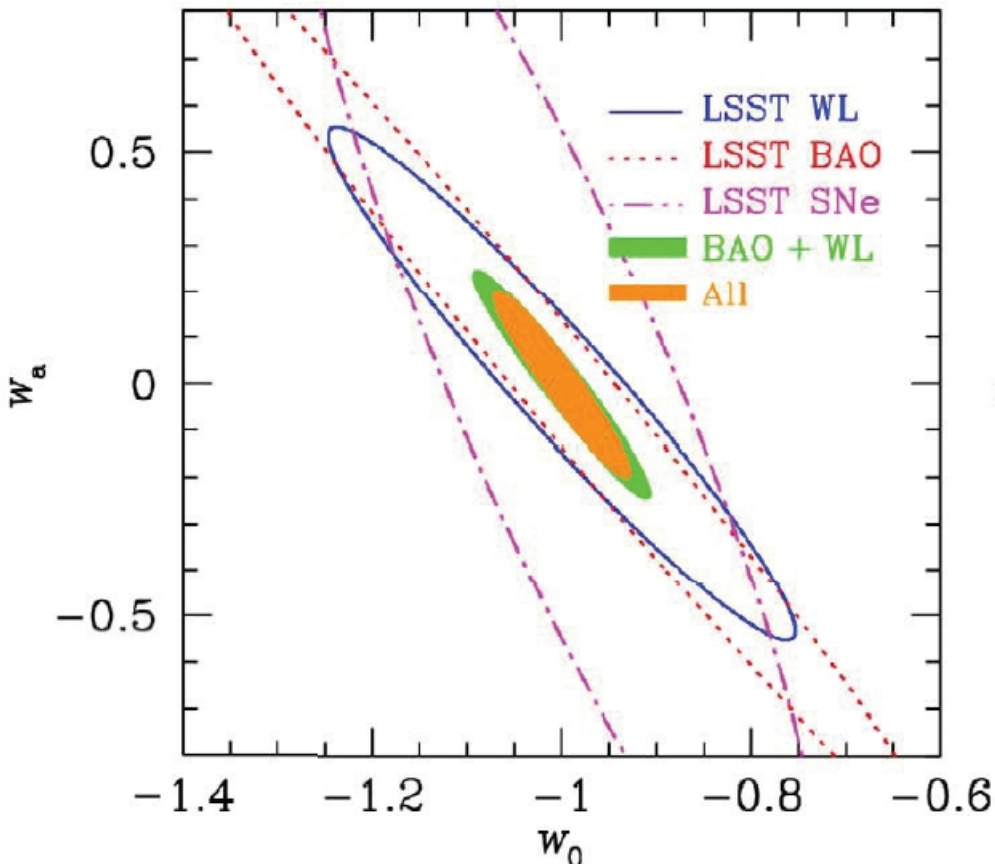

LSST Science Drivers

- The Fate of the Universe (Dark Energy and Matter): use a variety of probes and techniques in synergy to fundamentally test our cosmological assumptions and gravity theories:
 1. **Weak Lensing:** growth of structure
 2. **Galaxy Clusters:** growth of structure
 3. **Baryon Acoustic Oscillations:** standard ruler
 4. **Supernovae:** standard candle

About a hundred-to-thousand-fold increase in precision over precursor experiments: Stage IV Experiment (Dark Energy Task Force nomenclature)

Multiple accurate cosmological probes with the same facility (and data): by simultaneously measuring growth of structure and co-moving distances, **LSST data will tell us whether the recent acceleration is due to dark energy or modified gravity.**

The Solar System Inventory

Studies of the distribution of orbital elements as a function of color and size; studies of object shapes and structure using colors and light curves.

- **Near-Earth Objects:** about 100,000 **LSST is the only survey capable of delivering completeness specified in the 2005 Congressional NEO mandate to NASA** (to find 90% NEOs larger than 140m)
- **Main-Belt Asteroids:** about 10,000,000
- **Centaur, Jovian and non-Jovian Trojans, trans-Neptunian objects:** about 200,000
- **Jupiter-family and Oort-cloud comets:** about 3,000–10,000, with hundreds of observations per object
- **Extremely distant solar system:** the search for objects with perihelia at several hundred AU (e.g. Sedna will be observable to 200-300 AU).

Solar System as a detailed test of planet formation theories
(like the Galaxy is a detailed test of galaxy formation theories)

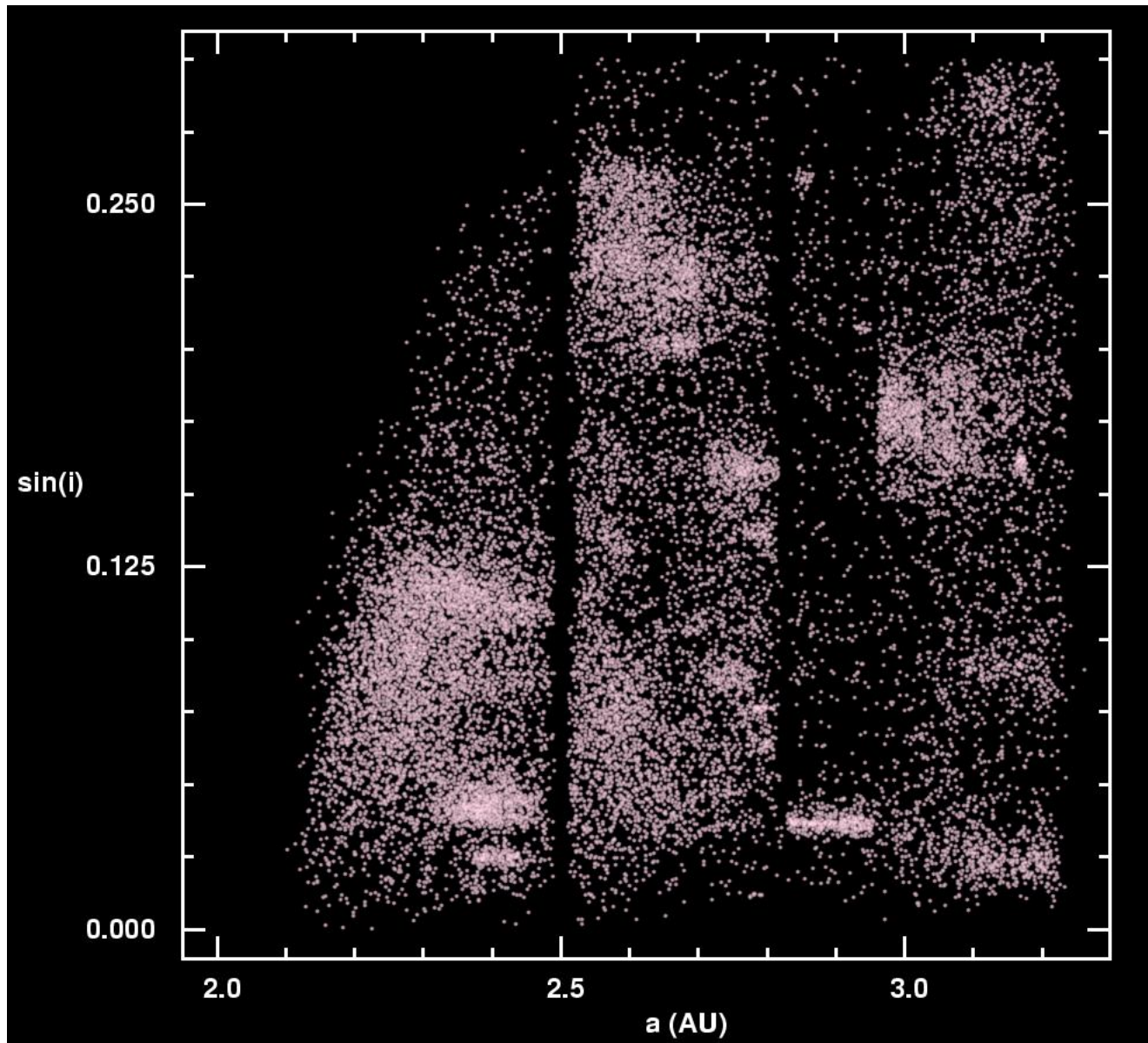

The semi-major axis vs. inclination (proper elements)

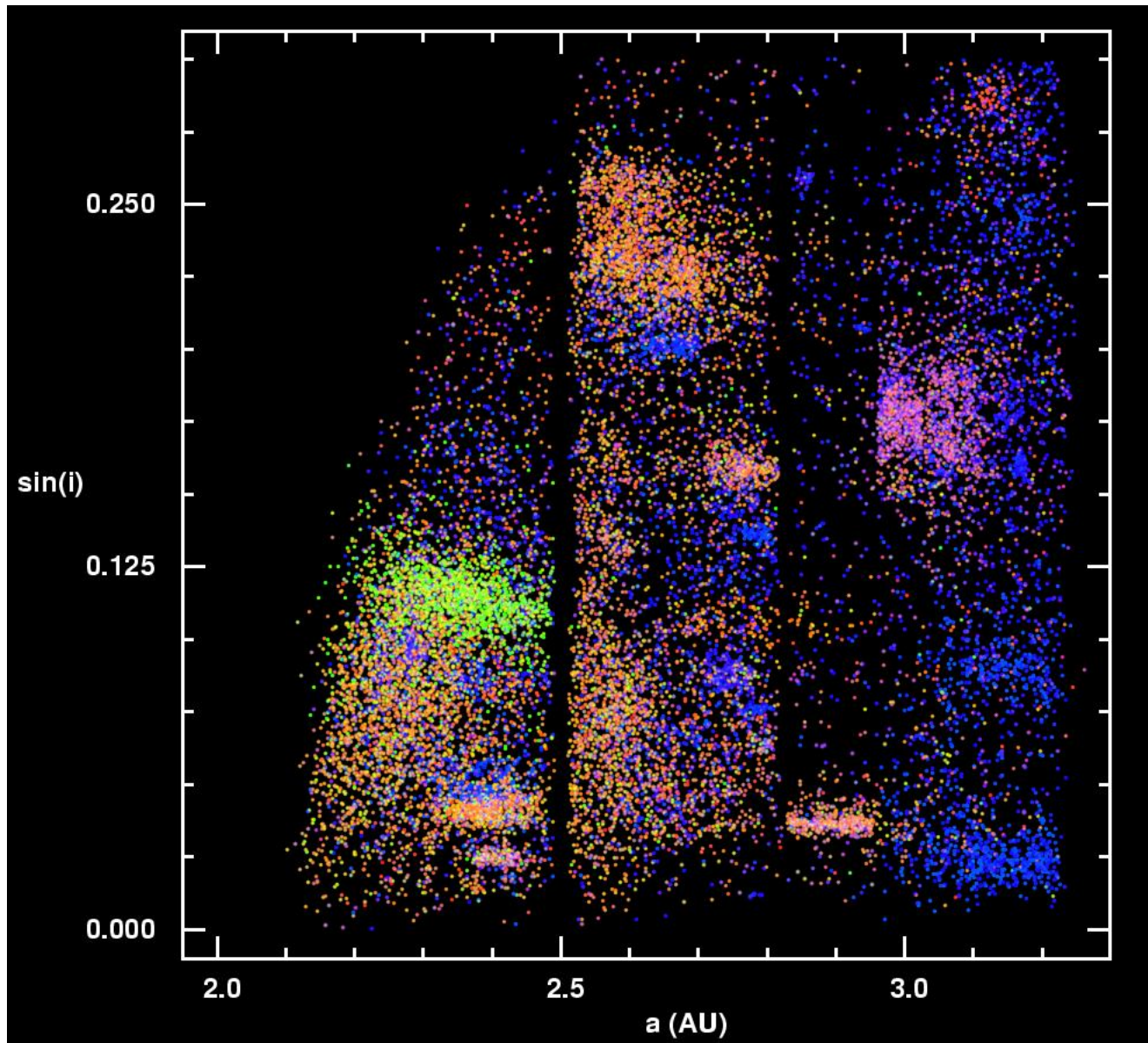

The semi-major axis vs. inclination: color-coded using optical colors measured by SDSS

Detailed population studies: Parker et al. (2008, Icarus 198, 138)

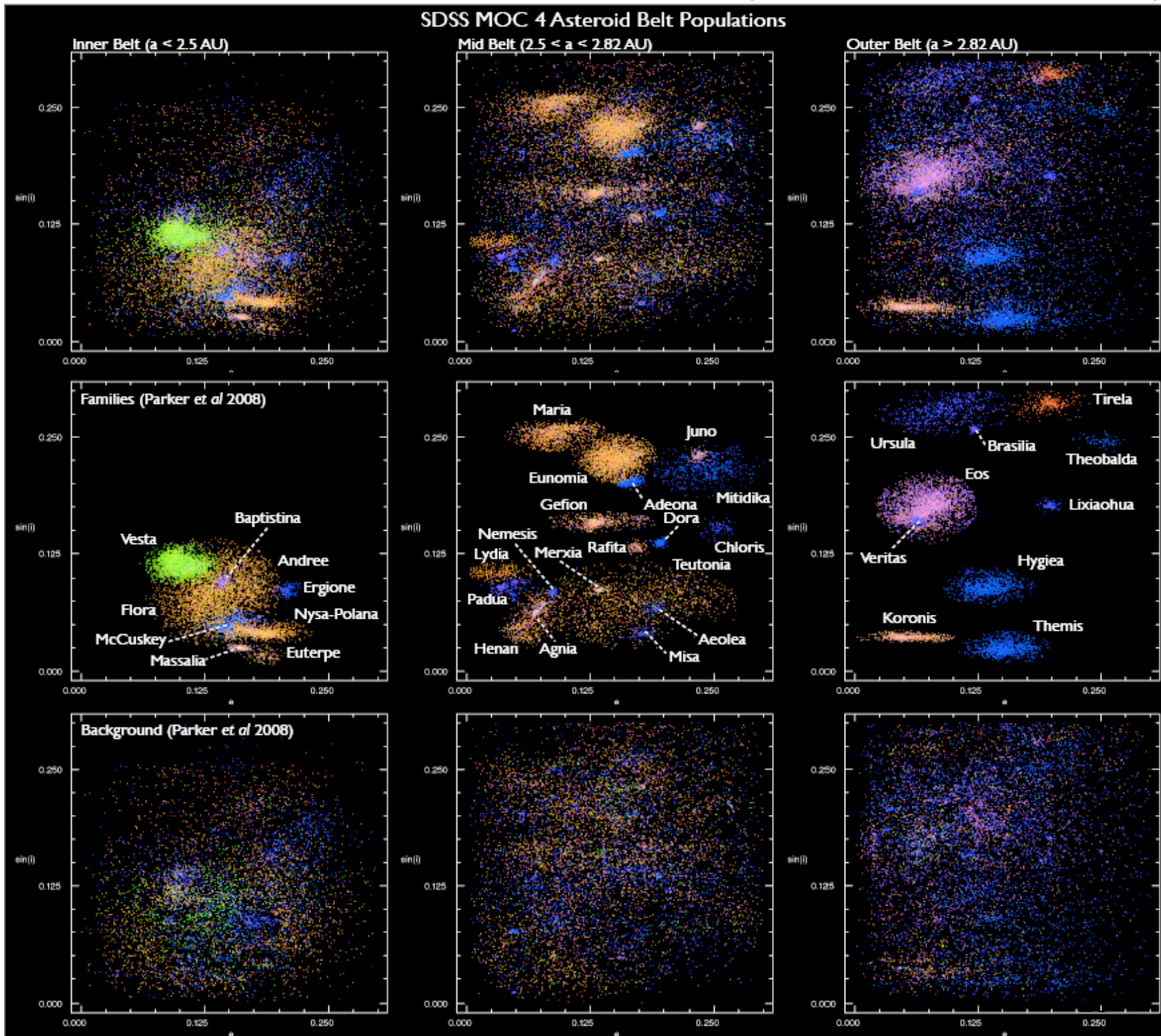

Size distributions of main-belt families: LSST will go 5 mag deeper!

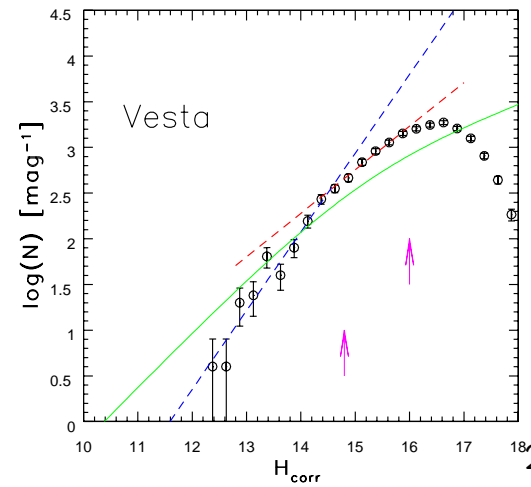
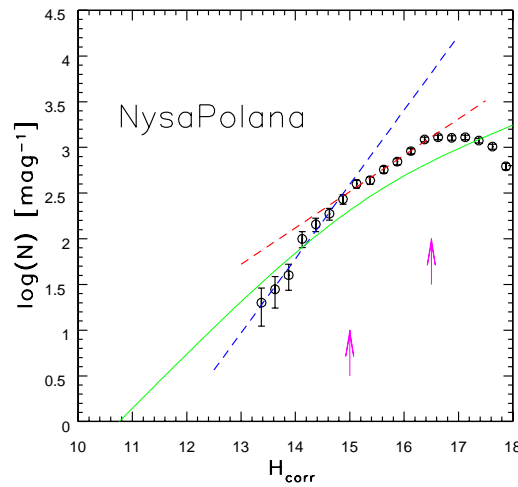
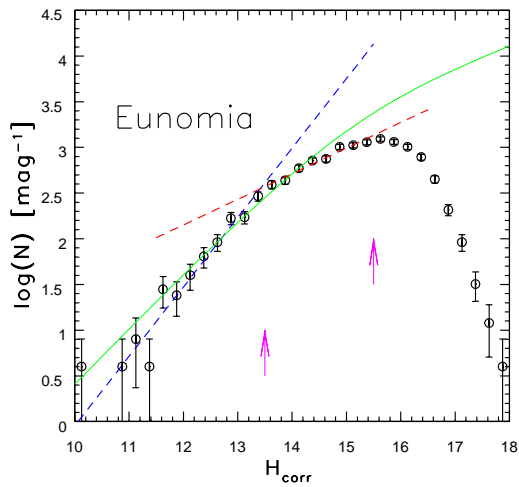
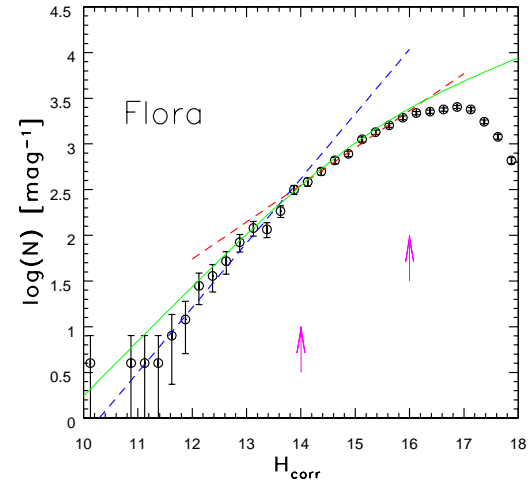
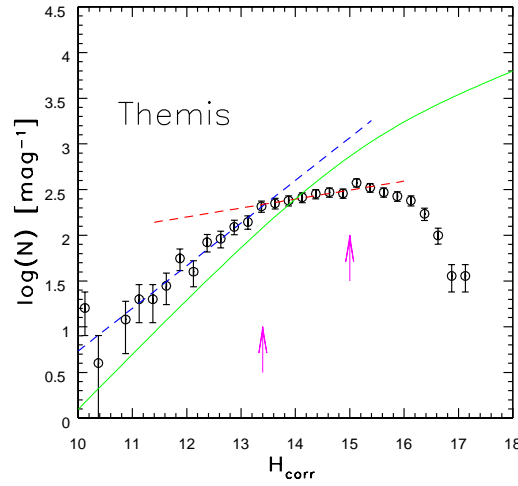
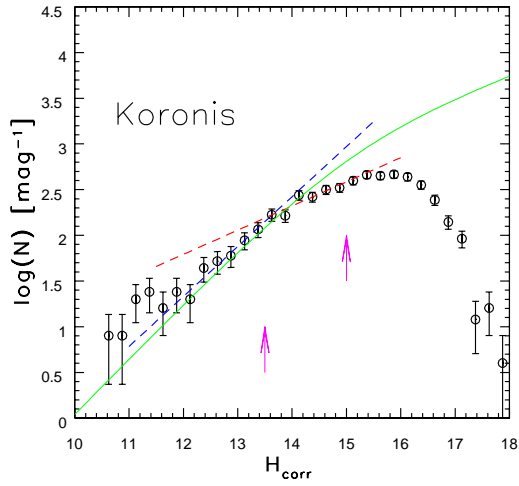
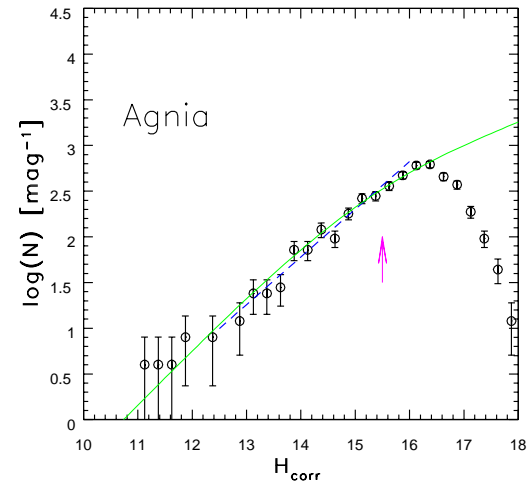
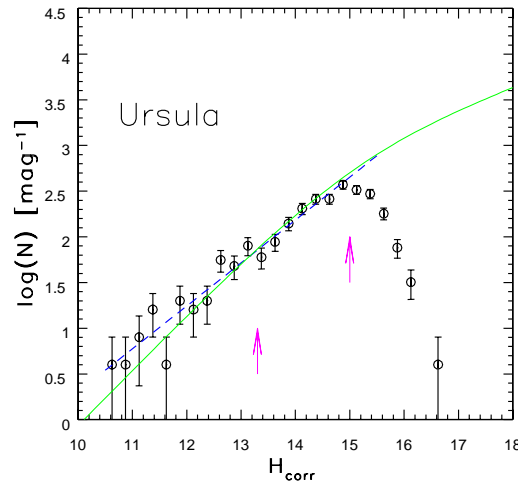
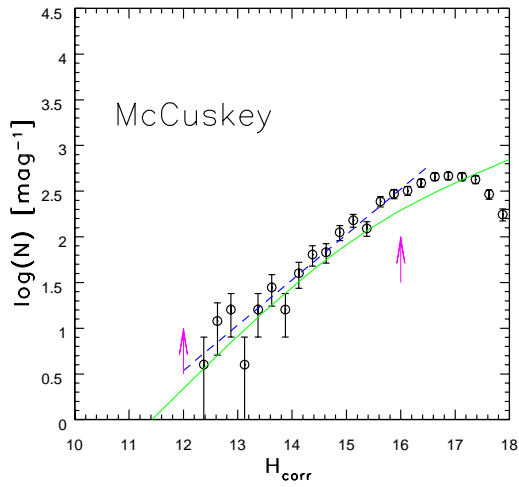

Time Domain: Exploring the Unknown

- Characterize known classes of transient and variable objects, and discover new ones: a variety of time scales ranging from ~ 10 sec, to the whole sky every 3 nights, and up to 10 yrs; large sky area, faint flux limit (as many **variable** stars in LSST as **all** stars in SDSS: ~ 100 million)
- Transients will be reported within 60 sec of closing shutter

Time Domain: Exploring the Unknown

- Characterize known classes of transient and variable objects, and discover new ones: a variety of time scales ranging from ~ 10 sec, to the whole sky every 3 nights, and up to 10 yrs; large sky area, faint flux limit (as many **variable** stars in LSST as **all** stars in SDSS: ~ 100 million)
- Transients will be reported within 60 sec of closing shutter

Not only point sources: echo of a supernova explosion

Science Image

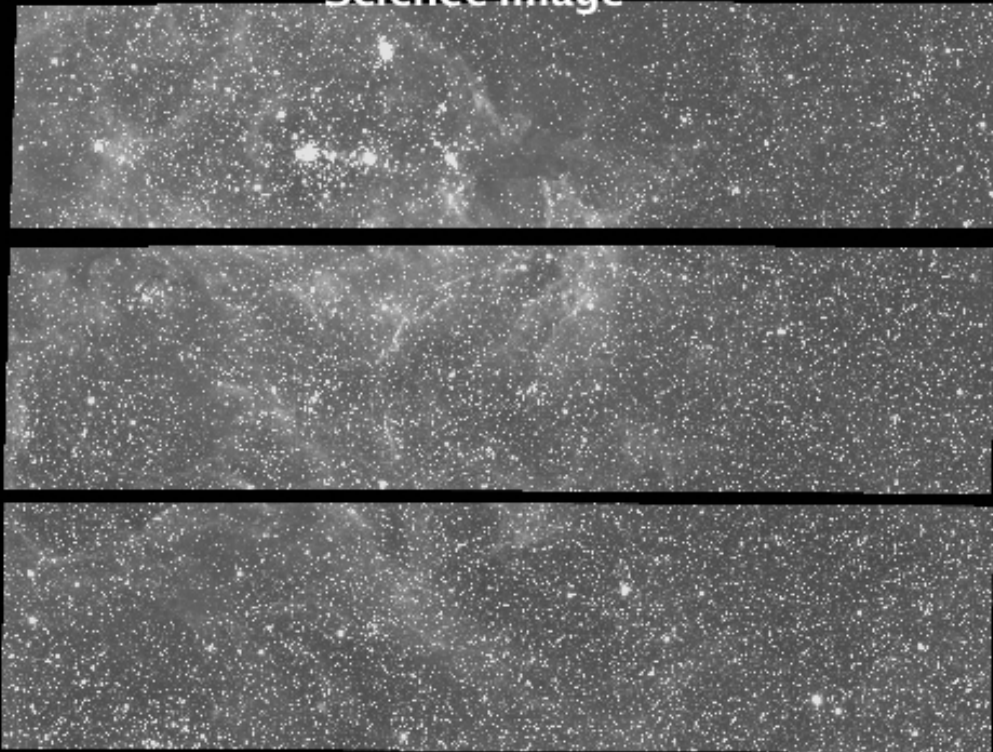

Difference Image (Science - Reference)

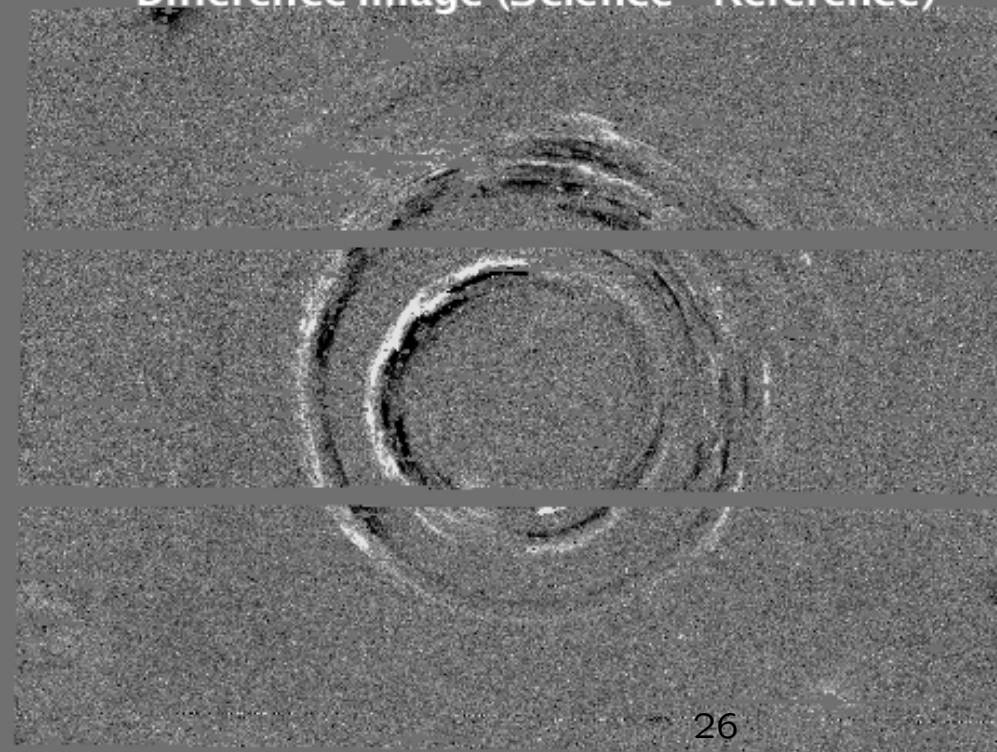

Quasar/AGN Variability

Variability is a tool, just like imaging, spectroscopy and multi-wavelength X-ray to radio observations, for studying quasars/AGNs

Competing theories for the origin of variability:

- Microlensing
- Bursts of Supernovae
- **Accretion disk instabilities**

SDSS observations indicate rich information content:

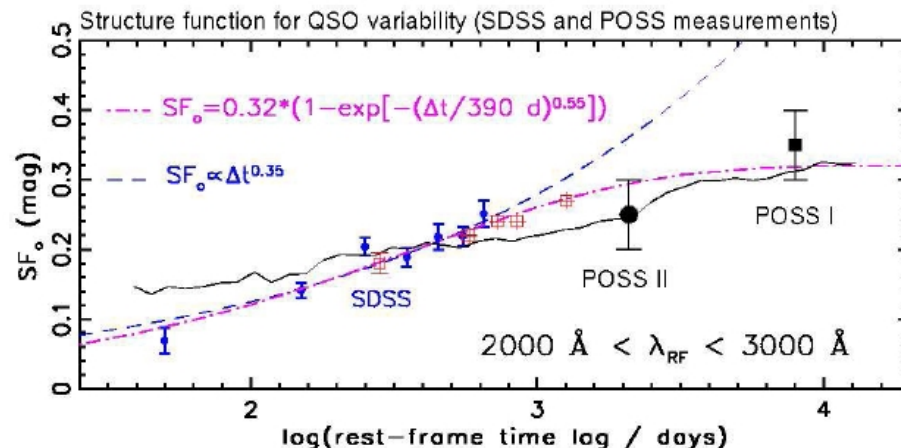
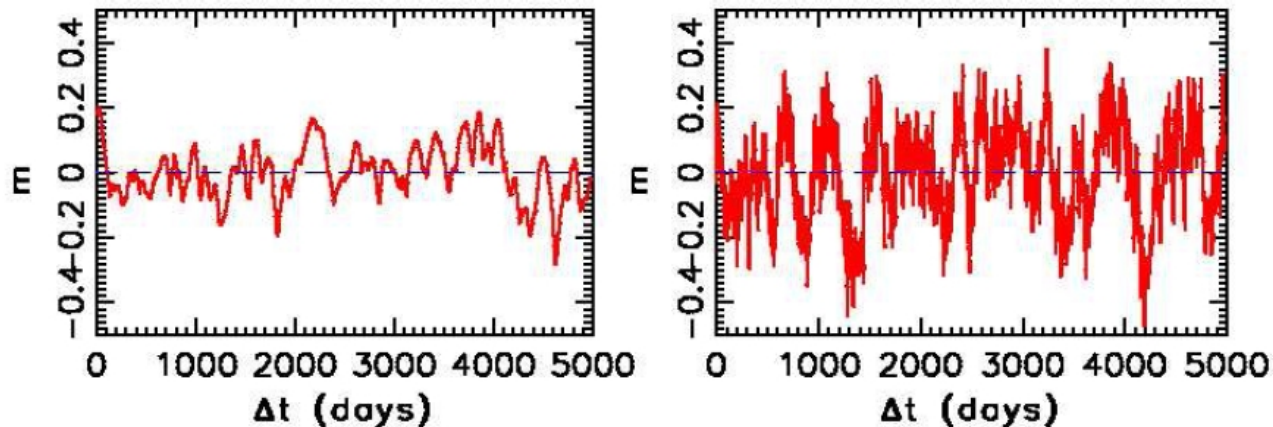

Quasar/AGN Variability

SDSS observations show that quasar variability depends on time scale, wavelength and luminosity, but **not on redshift** (vanden Berk et al. (2004); Ivezić et al. 2004; de Vries et al. (2005)).

Structure function as a function of λ , Δt , L and redshift

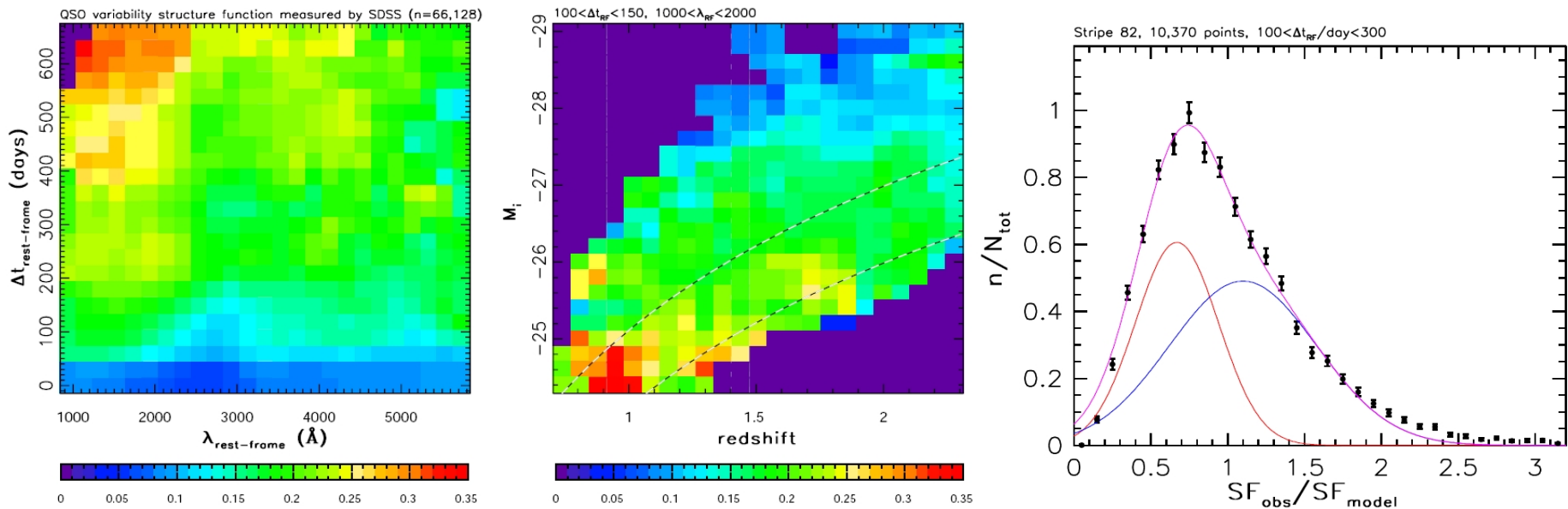

Are conclusions based on two-observations samples reliable?

SDSS Stripe 82: subsample of $\sim 10,000$ quasars with light curves: initial indications for two “populations” (MacLeod et al. 2008)

Quasar/AGN Variability

SDSS observations show that quasar variability depends on time scale, wavelength and luminosity, but **not on redshift**.

Initial indications for two “populations” (MacLeod et al. 2008)

MacLeod et al. (2010, arXiv:1004.0276): damped random walk model: excellent statistical description

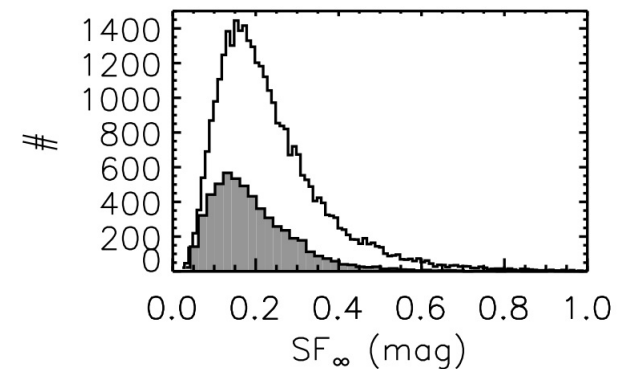
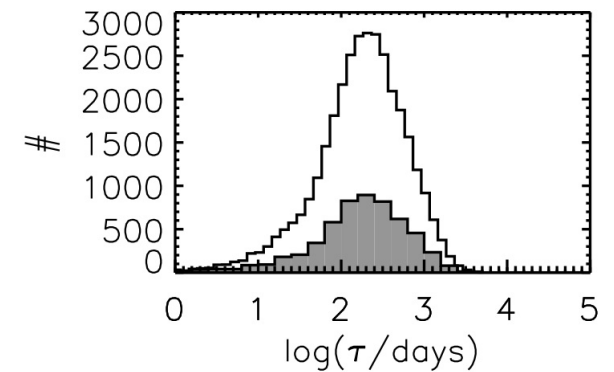
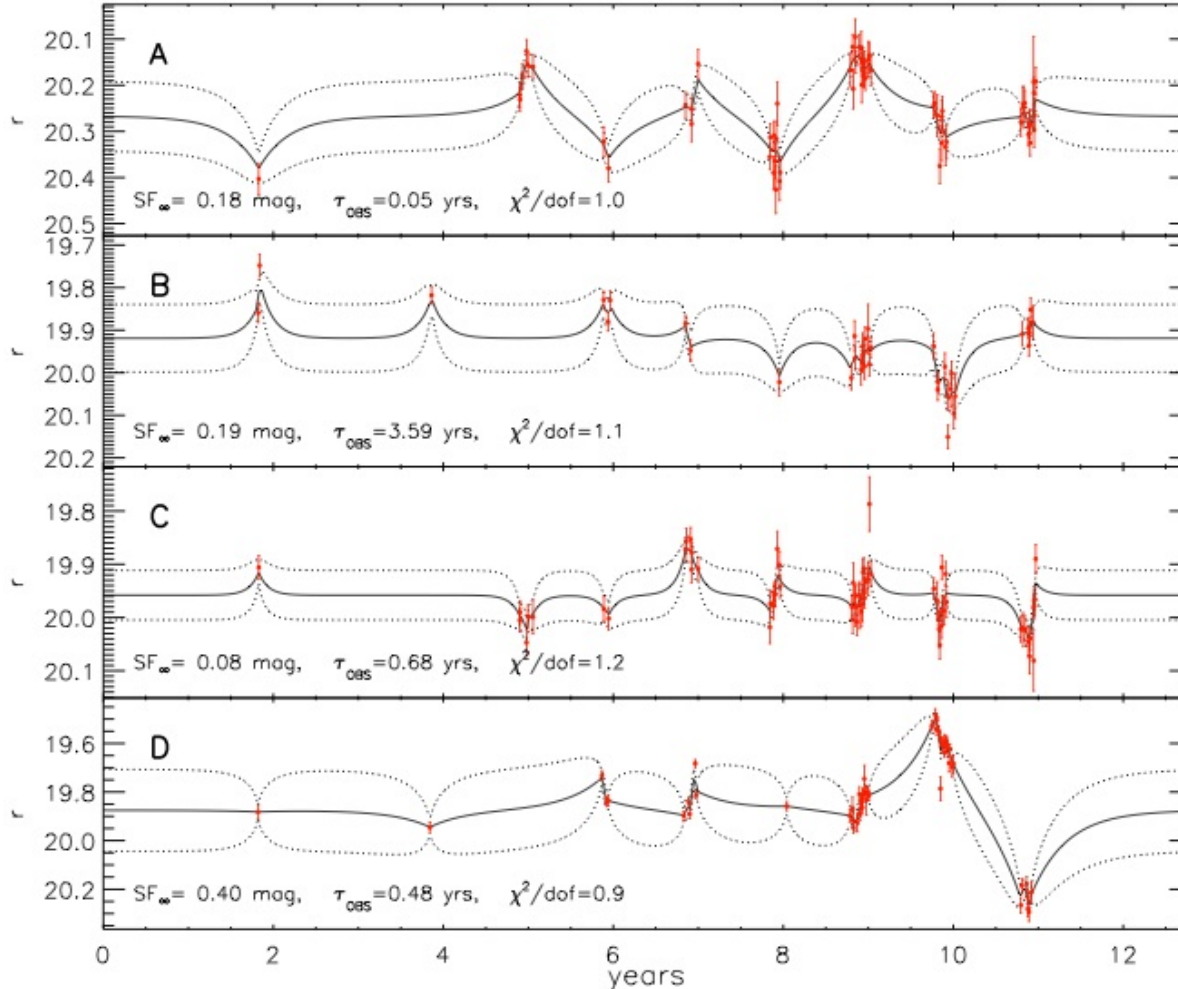

Quasar/AGN Variability

MacLeod et al. (2010): damped random walk model:

at a given wavelength, $SF(t) = SF_{\infty} [1 - \exp(-t/\tau)]^{1/2}$.

For $t < \tau$, $SF(t) \propto (t/\tau)^{1/2}$, with τ as an intrinsic parameter.

SDSS observations show that quasar variability is controlled by time scale, wavelength and luminosity, **and by stochastic τ** .

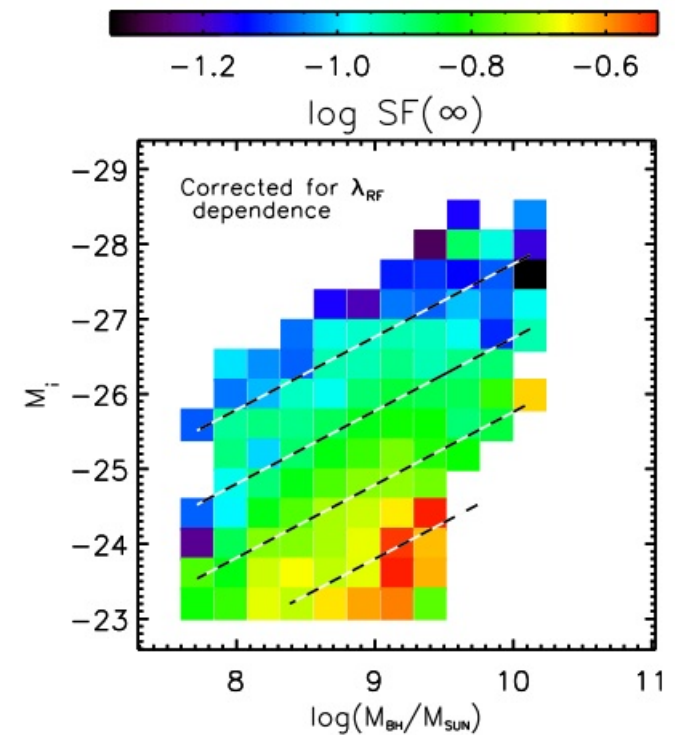
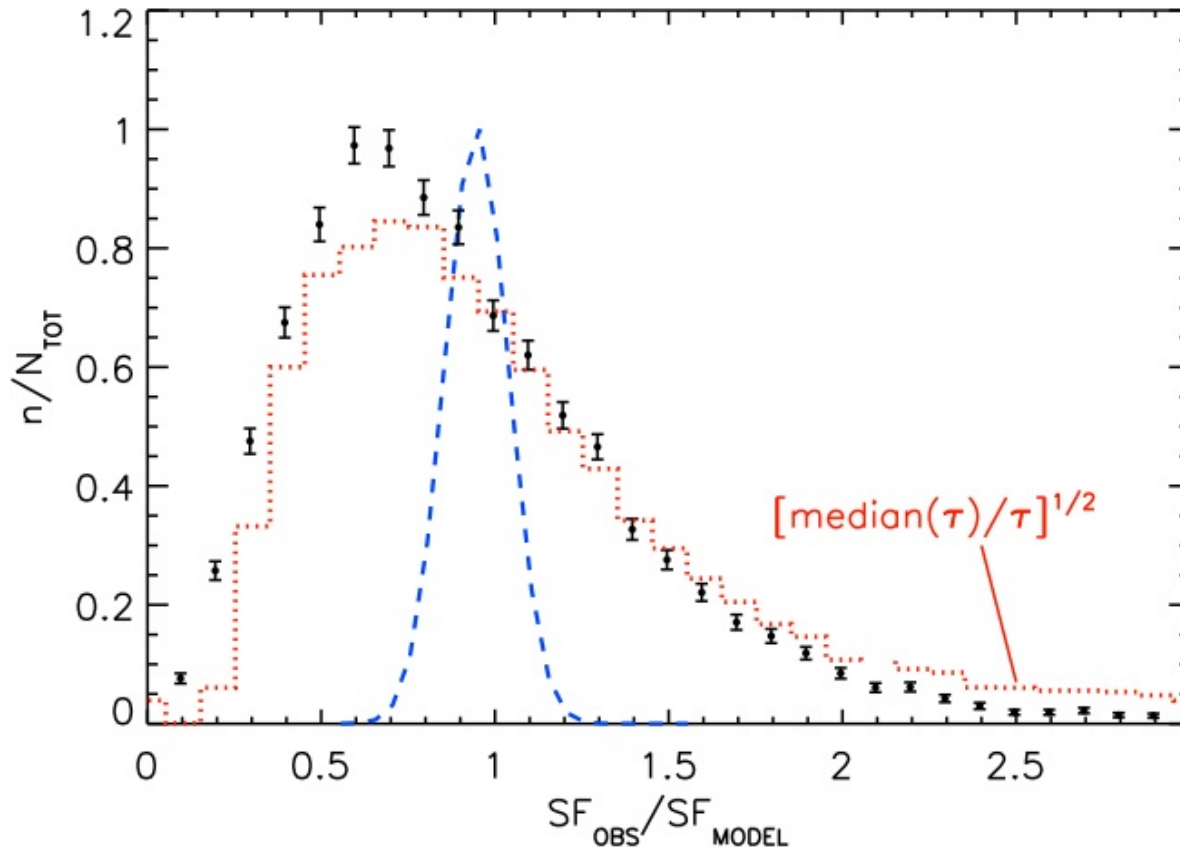

Quasar/AGN Variability

Datasets with only two observations per object do not capture all the information about variability: **damped random walk** is a convenient (if only statistical) tool to interpret data (Kelly et al. 2009; etc).

SDSS observations show that quasar variability depends on time scale, wavelength and luminosity, but **not on redshift**. The variability amplitude is strongly correlated with the Eddington factor, but there is additional impact of either luminosity or black hole mass.

Even when all these variables are controlled, the characteristic time scale still shows a fairly wide distribution.

LSST data will be excellent for continuing such studies (of accretion processes around black holes):

- About 100-1000 times larger sample
- Better sampling (uniform coverage, about 5 times more data points per object)

Classical Decomposition of the Milky Way Components

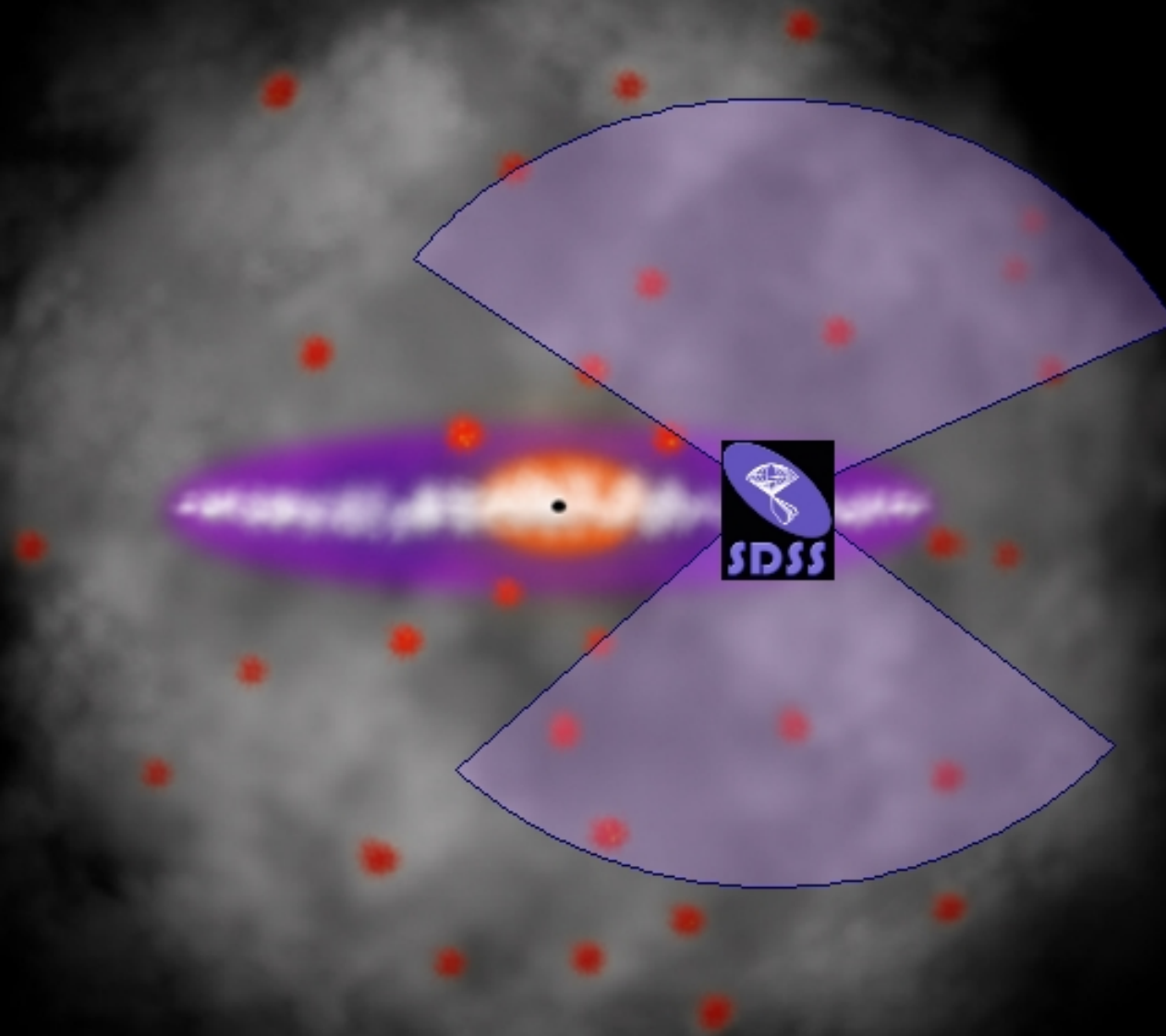

- Thin/thick disk
- Galactic bulge
- Stellar halo

- Components trace the DM dominated potential

- They are a product of Milky Way formation and evolution

A Primer on Dissecting the Milky Way with SDSS

- Stars on the main stellar locus are dominated ($\sim 98\%$) by main sequence stars (for $r > 14$)
- The position of main-sequence stars on the locus is controlled by their effective temperature/luminosity/[Fe/H], and thus can be used to estimate distance: photometric parallax method for ~ 100 million stars (with LSST several billion!)
- Accurate $u - g$ color enables photometric metallicity estimates for 6 million SDSS F/G stars to 10 kpc; (with LSST 200 million to 100 kpc!)

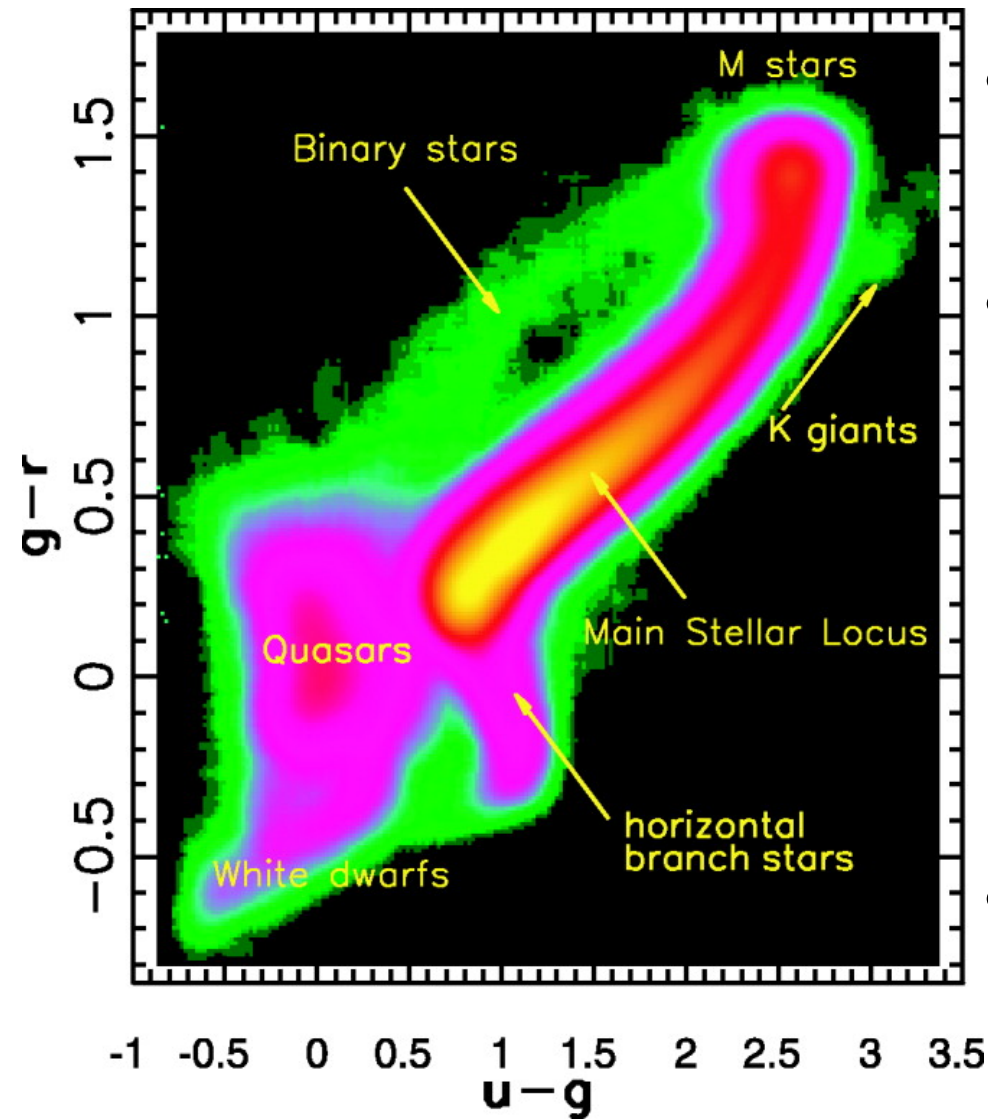

Wide wavelength coverage, and accurate and robust photometry

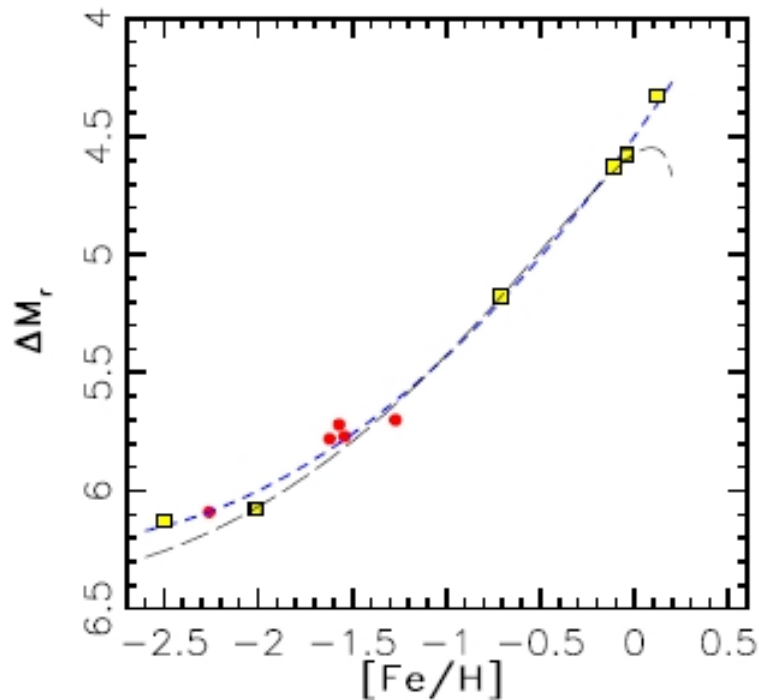
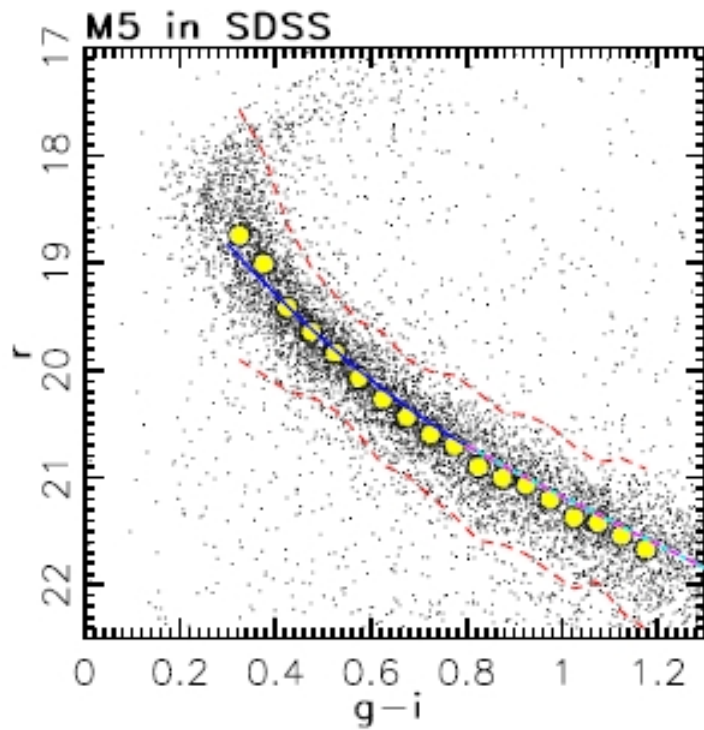

Photometric Distance and Photometric $[Fe/H]$

- Determined absolute magnitude vs. color vs. metallicity relation using globular clusters observed by SDSS (blue end), and nearby stars with trigonometric parallaxes (red end)
- The $g - i$ color of a main-sequence star constrains its absolute magnitude to within 0.1-0.2 mag (0.3 mag for unresolved binaries), assuming $[Fe/H]$ is known

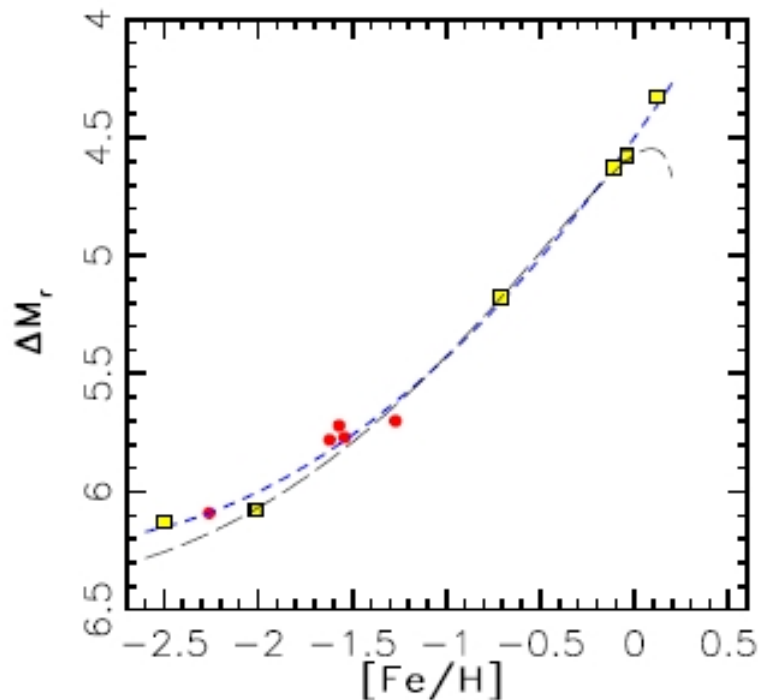
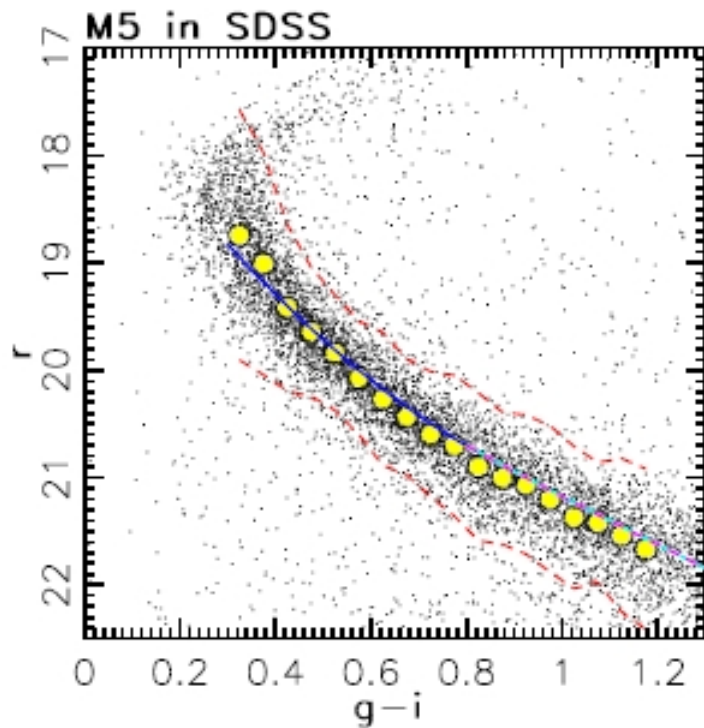

Photometric Distance and Photometric $[Fe/H]$

- Determined absolute magnitude vs. color vs. metallicity relation using globular clusters observed by SDSS (blue end), and nearby stars with trigonometric parallaxes (red end)
- The $g - i$ color of a main-sequence star constrains its absolute magnitude to within 0.1-0.2 mag (0.3 mag for unresolved binaries), assuming $[Fe/H]$ is known

This method was known half a century ago, but never before applied to tens of millions of stars because large-scale surveys did not have the required photometric accuracy

Photometric Distance and Photometric [Fe/H]

- Determined absolute magnitude vs. color vs. metallicity relation using globular clusters observed by SDSS (blue end), and nearby stars with trigonometric parallaxes (red end)
- The $g - i$ color of a main-sequence star constrains its absolute magnitude to within 0.1-0.2 mag (0.3 mag for unresolved binaries), assuming [Fe/H] is known
- **For F and G stars** ($0.2 < g - r < 0.6$), accurate SDSS $u - g$ color measurements enable photometric metallicity estimates as precise (0.1-0.2 dex) as [Fe/H] derived from SDSS spectra!

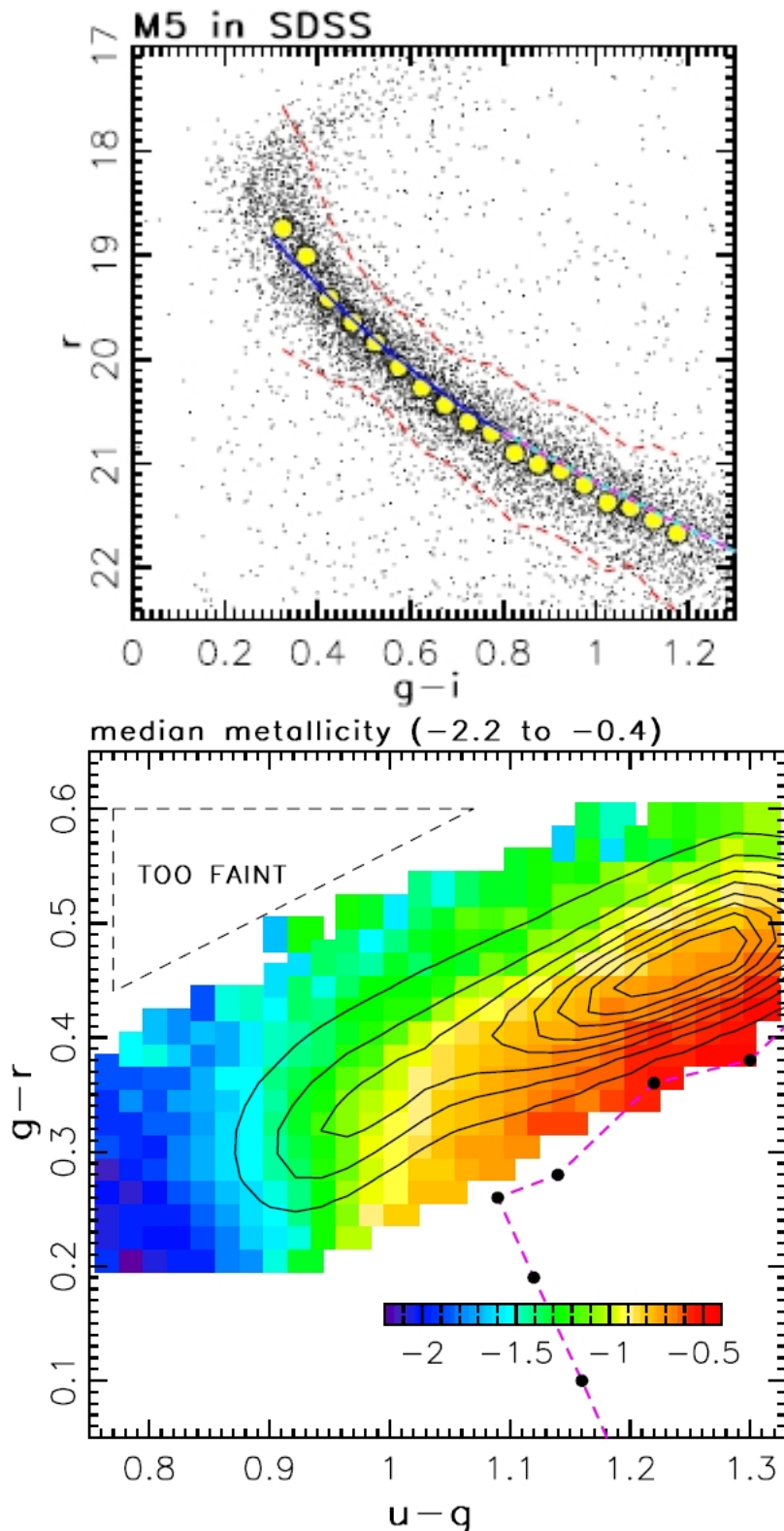

0.35 < r-i < 0.40

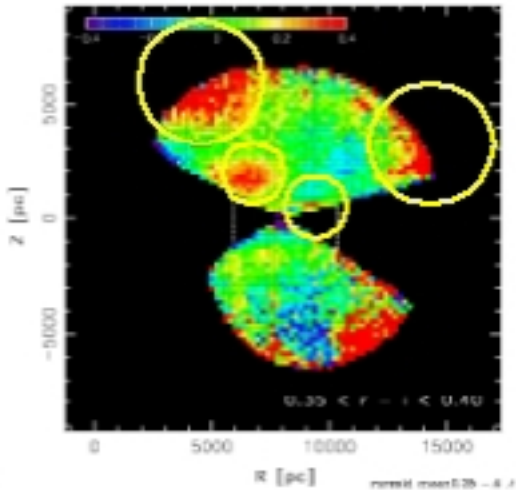
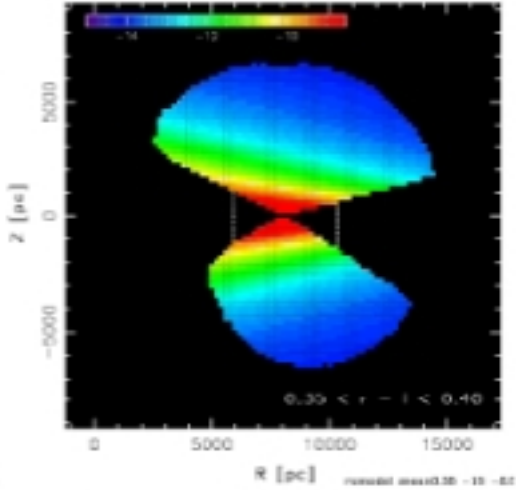
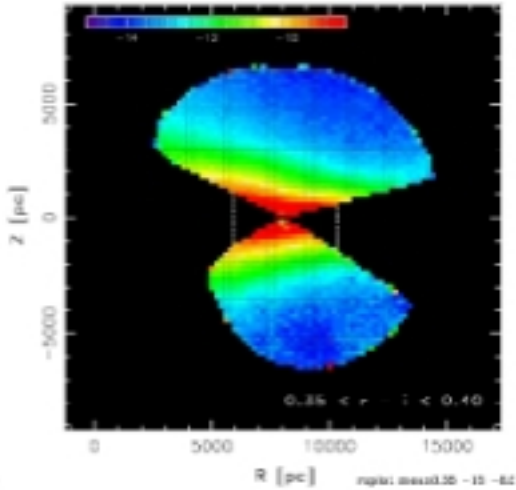

Dissecting the Milky Way with SDSS

- Panoramic view of the Milky Way, akin to observations of external galaxies; good support for standard Galactic models with amazing signal-to-noise! (Jurić et al. 2008)

- Removal of obvious clumps
- Fit to least “contaminated” bins
- Exponential disks + halo models

$$\rho(R,Z) = \rho_{thin} e^{-\frac{R-R_g}{l_{thin}} - \frac{|Z+Z_0|}{h_{thin}}} + \rho_{thick} e^{-\frac{R-R_g}{l_{thick}} - \frac{|Z+Z_0|}{h_{thick}}} + \rho_{halo} \left(\frac{R_{GC}}{\sqrt{R^2 + (z+z_0)^2 / q^2}} \right)^n$$

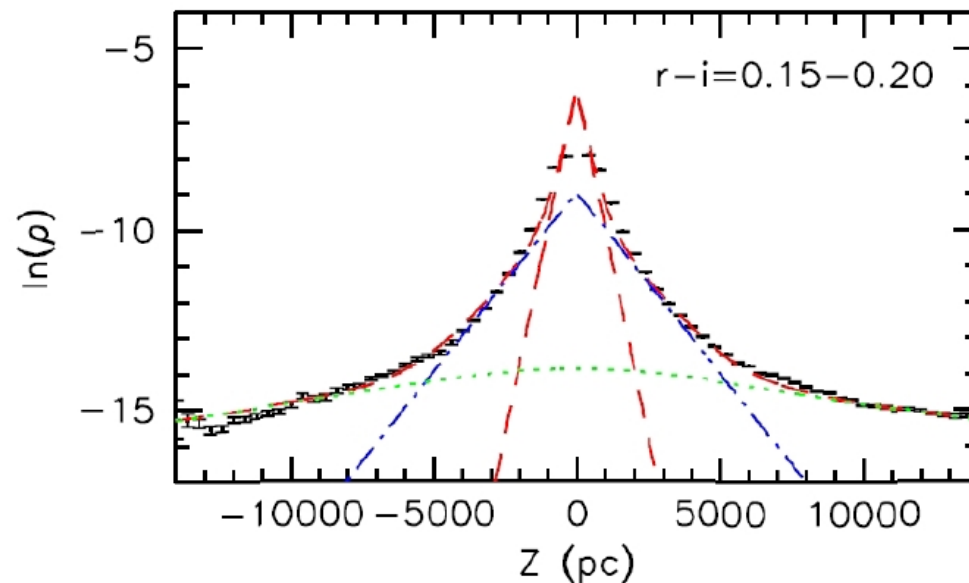

The r-i color bins sample a variety of scales

19 r-i color bins - 19 density maps



r-i	0.1	0.2	0.4	0.6	0.8	1	1.2	1.4
D [kpc]	15	13	7	4	3	2	1.5	1
SpT	~F9	G6	K4	K7	M0	M1	M2	M3

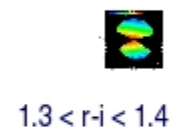
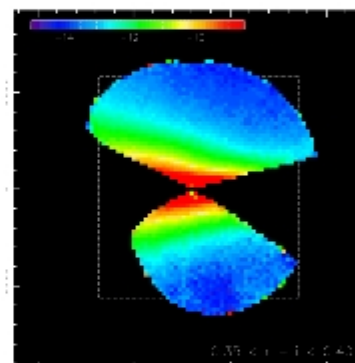
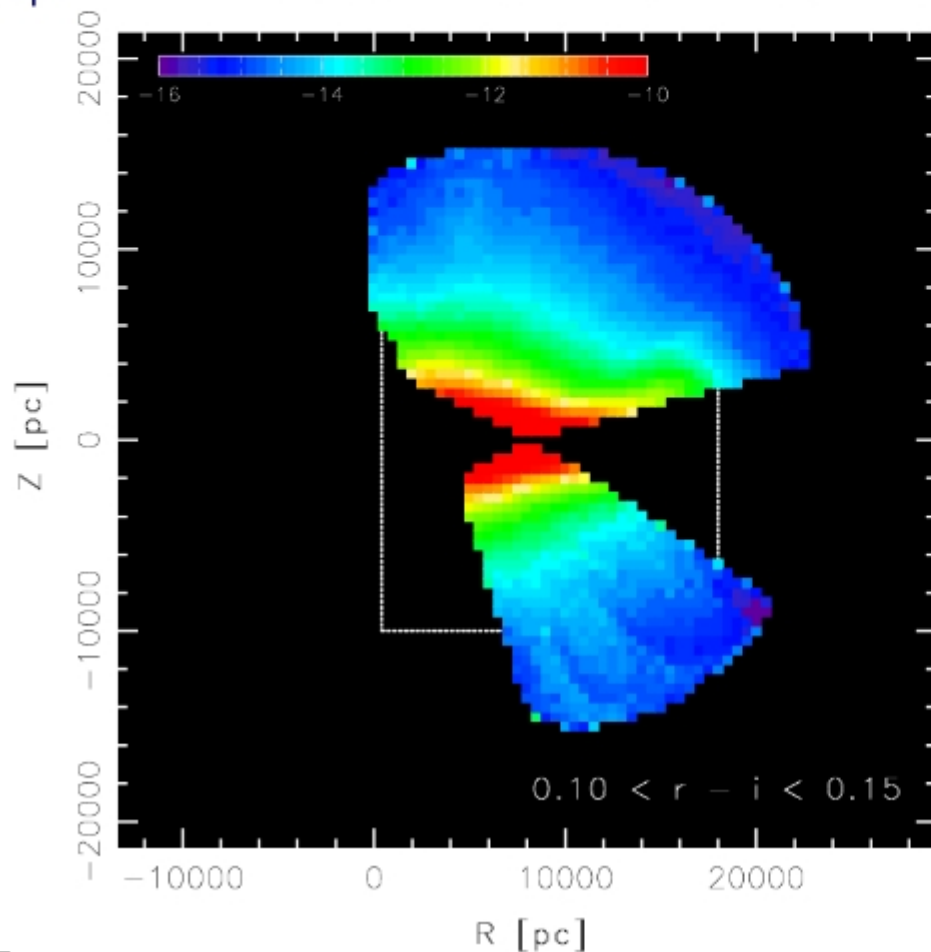

0.35 < r-i < 0.40

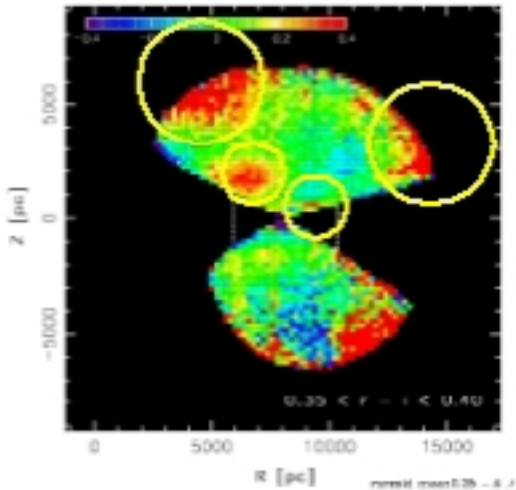
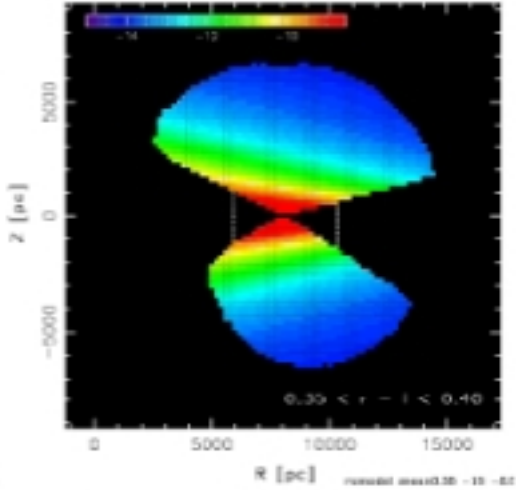
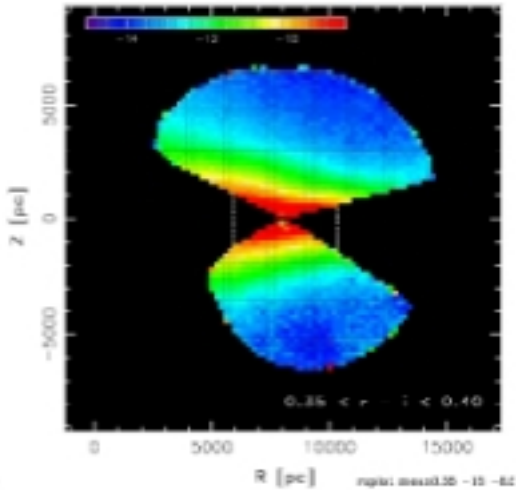

Dissecting the Milky Way with SDSS

- Panoramic view of the Milky Way, akin to observations of external galaxies; good support for standard Galactic models (with amazing signal-to-noise!)

- Removal of obvious clumps
- Fit to least “contaminated” bins
- Exponential disks + halo models

$$\rho(R, Z) = \rho_{thin} e^{-\frac{R-R_g}{l_{thin}} - \frac{|Z+Z_0|}{h_{thin}}} + \rho_{thick} e^{-\frac{R-R_g}{l_{thick}} - \frac{|Z+Z_0|}{h_{thick}}} + \rho_{halo} \left(\frac{R_{GC}}{\sqrt{R^2 + (z+z_0)^2 / q^2}} \right)^n$$

- The merger history of the Milky Way can be deciphered by mapping the substructure (spatially, and in velocity space, as a function of chemical composition [metallicity])

$0.35 < r-i < 0.40$

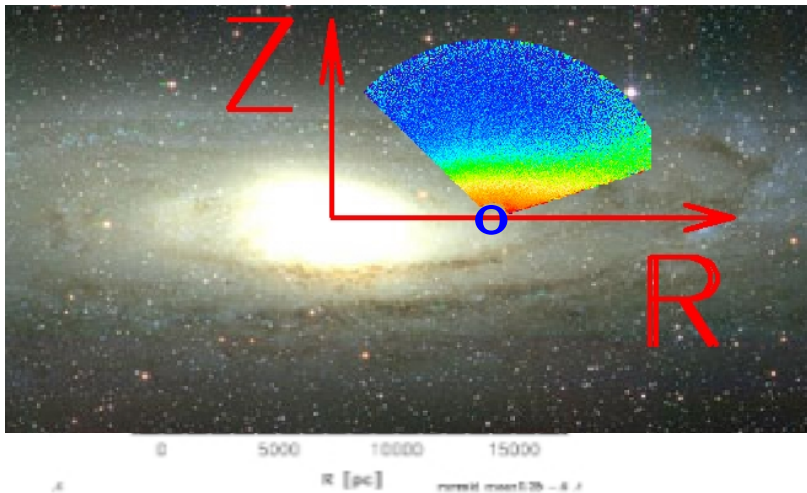
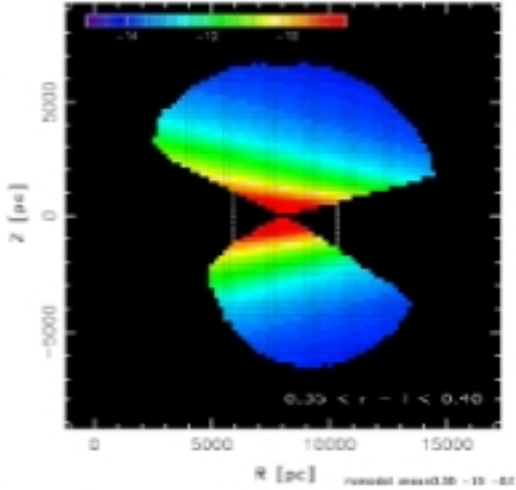
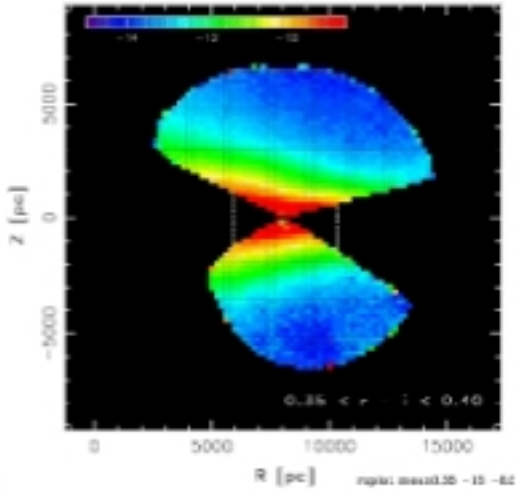

Dissecting the Milky Way with SDSS

- Panoramic view of the Milky Way, akin to observations of external galaxies; good support for standard Galactic models (with amazing signal-to-noise!)
- Metallicity mapping supports components inferred from number counts mapping:

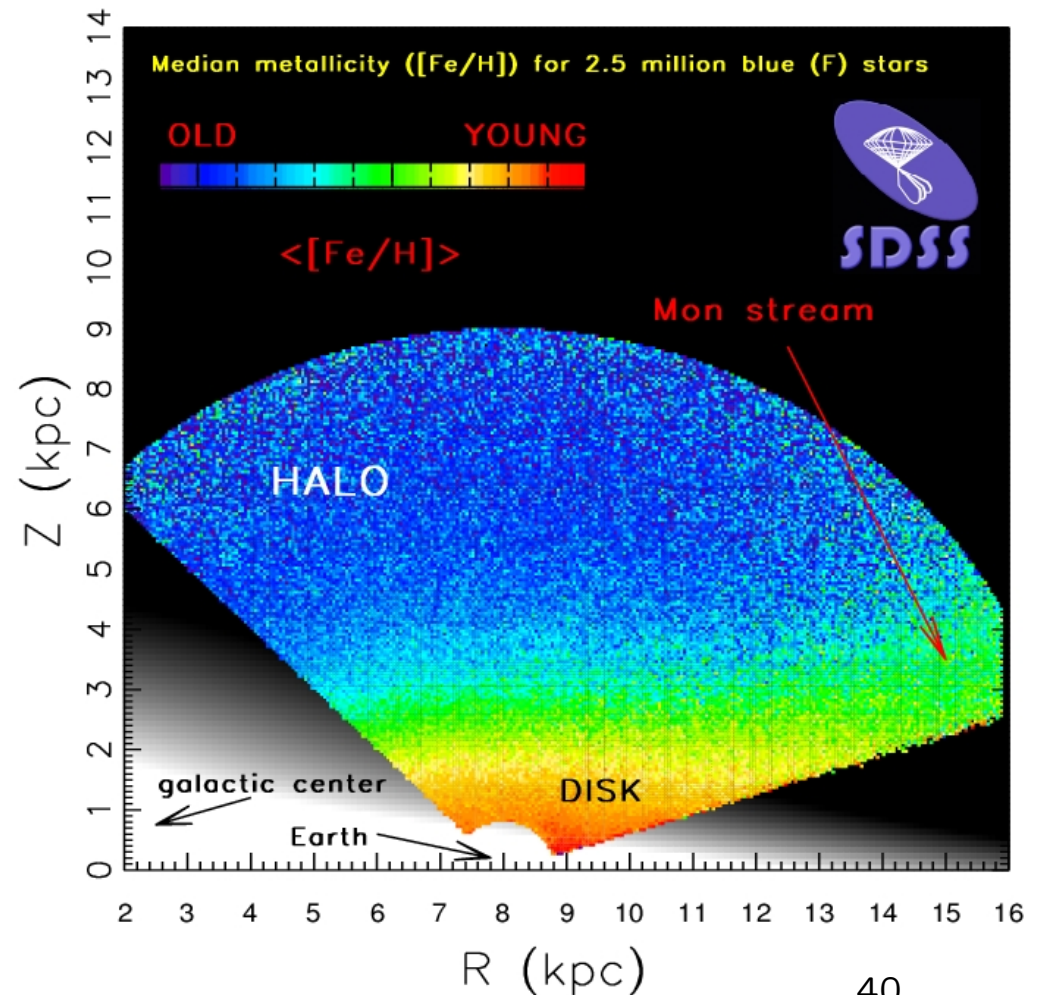

$0.35 < r-i < 0.40$

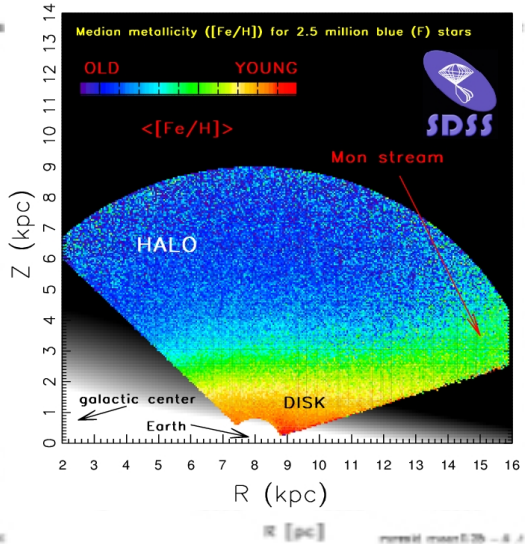
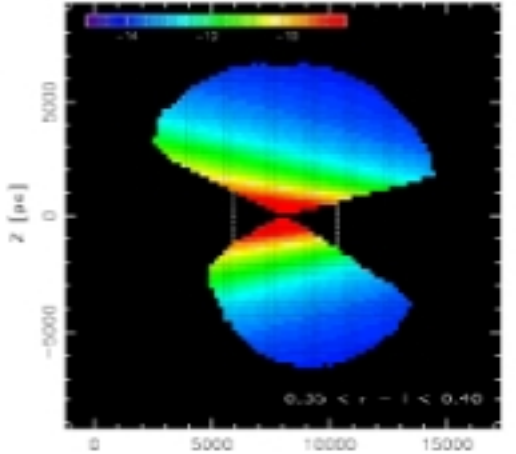
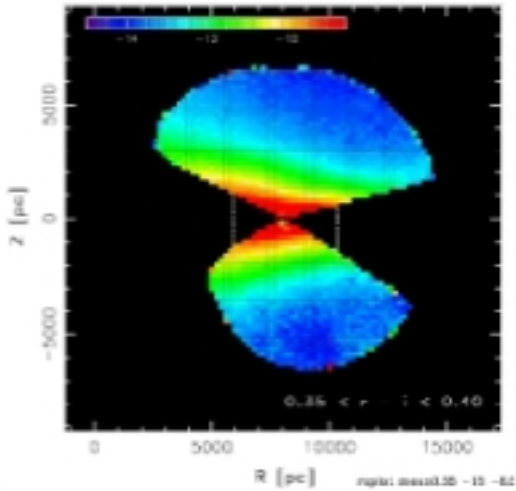

Dissecting the Milky Way with SDSS

- Panoramic view of the Milky Way, akin to observations of external galaxies; good support for standard Galactic models (with amazing signal-to-noise!)
- Metallicity mapping supports components inferred from number counts mapping
- Kinematics correlated with metallicity: high-metallicity (disk) stars rotate, low-metallicity (halo) stars on random highly eccentric orbits

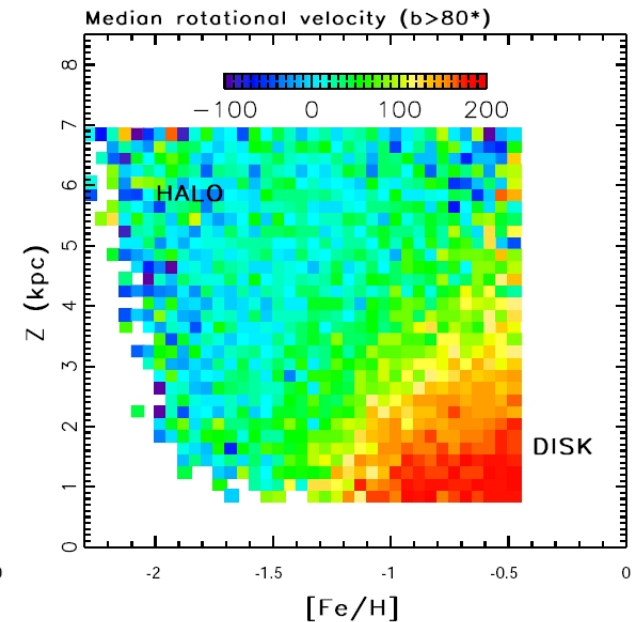
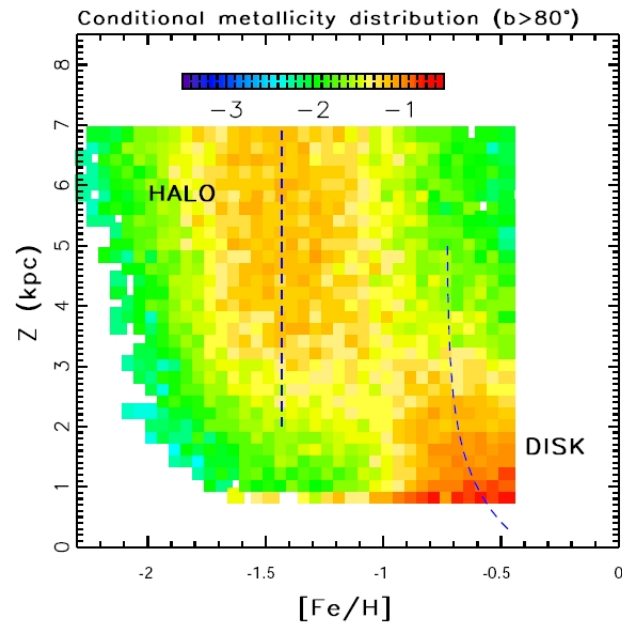

Halo Velocity Ellipsoid Tilt

- Three two-dimensional projections of the velocity distribution for two subsamples of candidate halo stars ($[Fe/H] < -1.1$) with $6 < R/\text{kpc} < 11$, and $3 < Z/\text{kpc} < 4$ (top) and $-4 < Z/\text{kpc} < -3$ (bottom)
- The v_Z vs. v_R velocity ellipsoid is aligned with spherical coordinate system (Bond et al. 2010). Confirms results of Smith et al. (2009) over 30 times larger area.

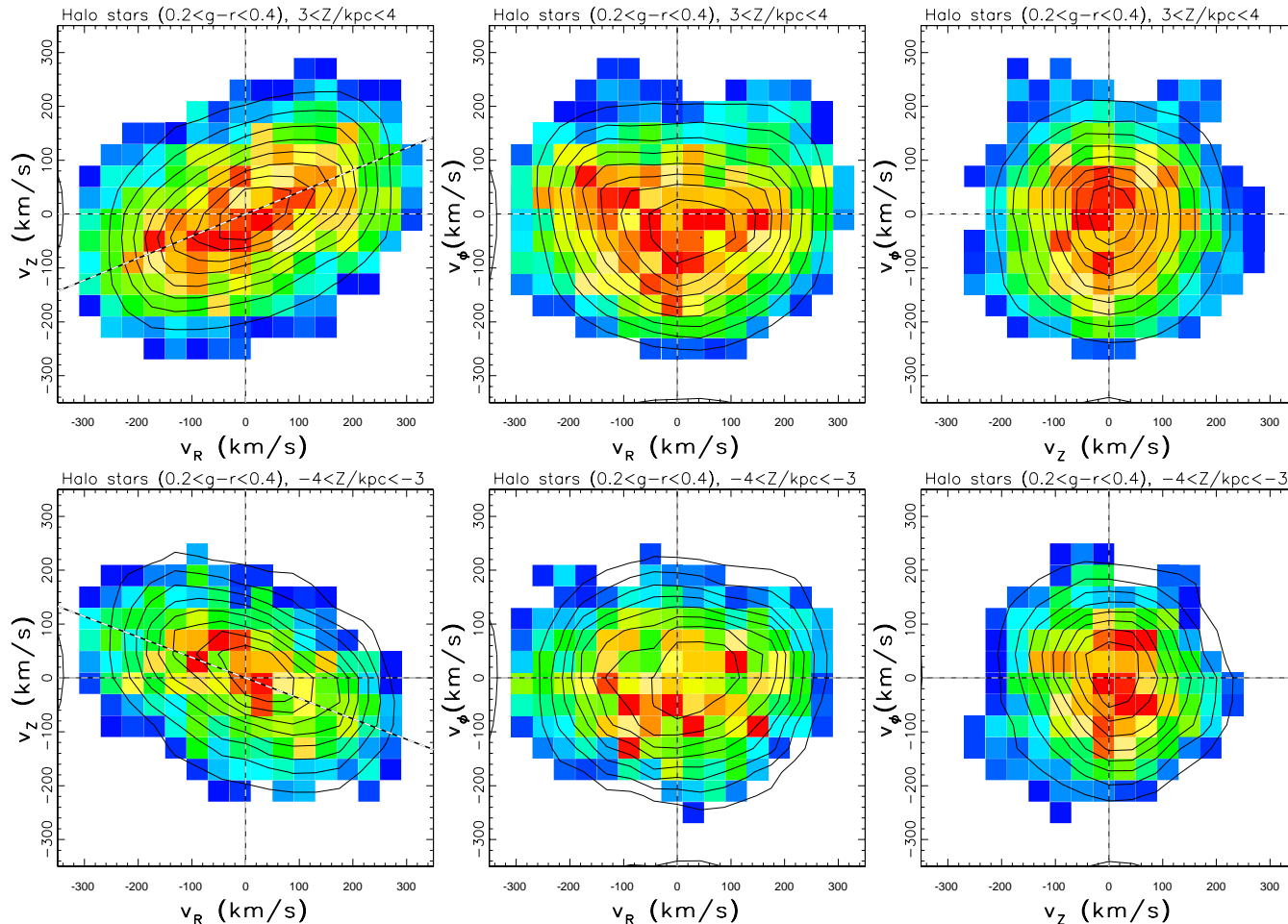

Empirical Model for Mock Catalogs: **Galfast**

- **Web service by Mario Jurić** based on smooth spatial, metallicity and kinematics distributions measured by SDSS
- Available from www.mwscience.net/galfast
- A valuable tool when searching for substructure in data, or comparing to theoretical models
- For example, can easily make mock catalogs for surveys such as SDSS, Pan-STARRS, Gaia, ODI and LSST

The screenshot shows the Galfast web interface. The browser address bar is `http://hybrid.mwscience.net/galfast/?jobid=4`. The page title is "mwscience.net :: Galactic Model Generator beta :: Mario Jurić :: Mon Aug 3 05:21:28 2009".

Job Options:

- Description: Flux limited/volume cut LSST sampl
- E-mail for notification: majuric@gmail.com
- Send e-mail on completion:
- Random seed: 42
- Output in FITS format:
- Skip Q/A plot generation:
- Make this a template for new jobs:

Model:

- Maximum stars to generate: 50e6

Density Components:

- Exp Disk and Power Law Halo (model_5cc3d9.conf):**
- Model type: Exp Disk and Power Law Halo
- Enabled:
- Solar offset (Z_0): 24
- Thin disk parameters (ρ_0, L_1, H_1): 1, 2150, 245
- Thick disk parameters (f_D, L_2, H_2): 0.13, 3261, 743
- Halo parameters (f_H, n_H, q): 0.0051, 2.77, 0.64
- Cutoff radius (r_{cut} in pc): 100000
- Luminosity function band (M_x): LSSTz
- Luminosity function, $\Phi(M_x)$: MzLF.f.txt

Observed area:

Help Panel: Double-exponential density profile (with Jurić et al. 2008, defaults)

This model describes the density in terms of three components: the thin and thick disks (double-exponentials), and a power-law halo. The profiles are as follows:

$$\rho(R, Z) = \rho_{thin}(R, Z) + \rho_{thick}(R, Z) + \rho_H(R, Z)$$
$$\rho_{thin}(R, Z) = \rho_0 e^{-\frac{R}{L_1}} \exp\left(-\frac{R}{L_1} - \frac{Z + Z_0}{H_1}\right)$$
$$\rho_{thick}(R, Z) = f_D \rho_0 e^{-\frac{R}{L_2}} \exp\left(-\frac{R}{L_2} - \frac{Z + Z_0}{H_2}\right)$$
$$\rho_H(R, Z) = \rho_0 f_H \left(\frac{R_0}{\sqrt{R^2 + (Z/q_H)^2}}\right)^{n_H}$$

The density is truncated to zero beyond r_{cut} galactocentric distance.

Reference: [Jurić et al. 2008](#)

Solar offset Z_0 : The offset of the Sun from the Galactic plane (parsecs).

Buttons: Save changes, Queue, Clone, Clean, Delete

Page number: 43

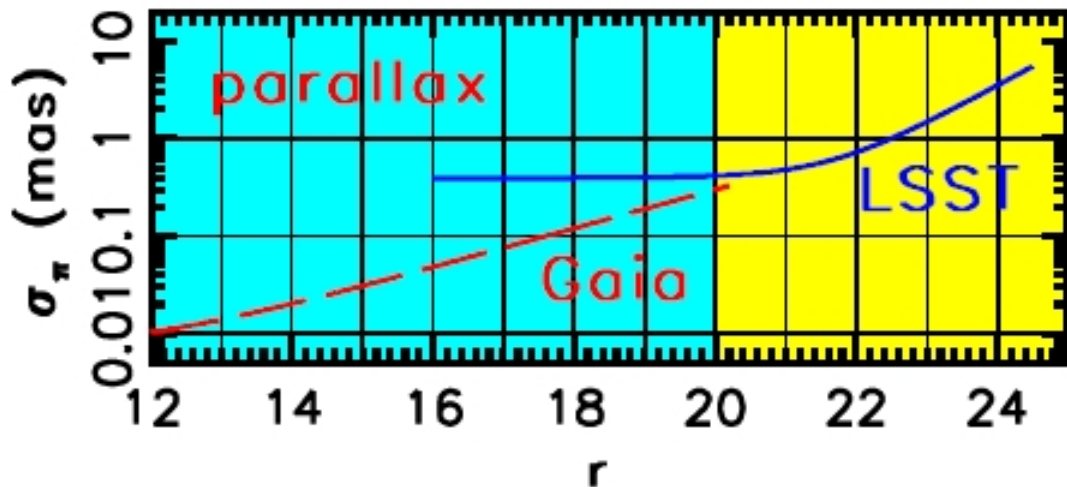
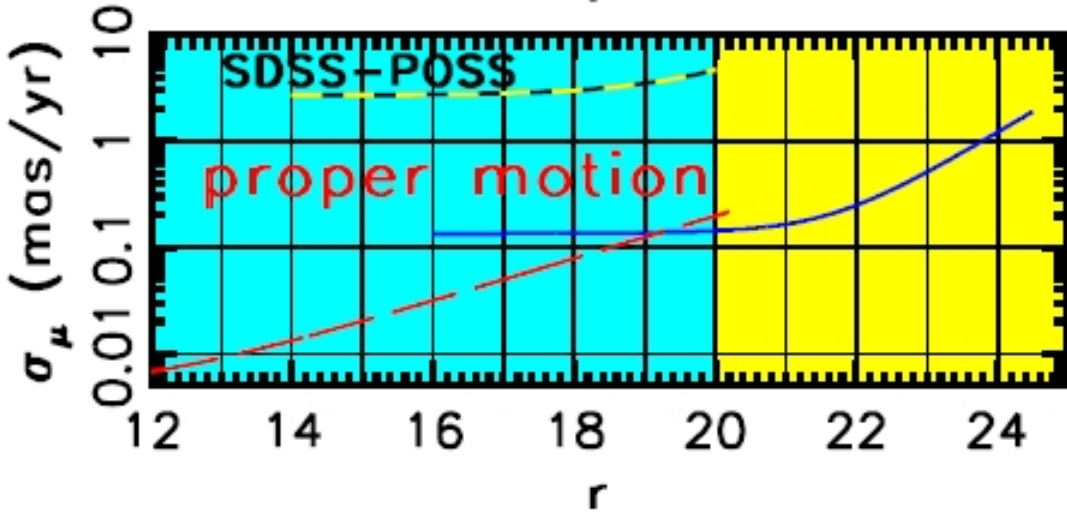
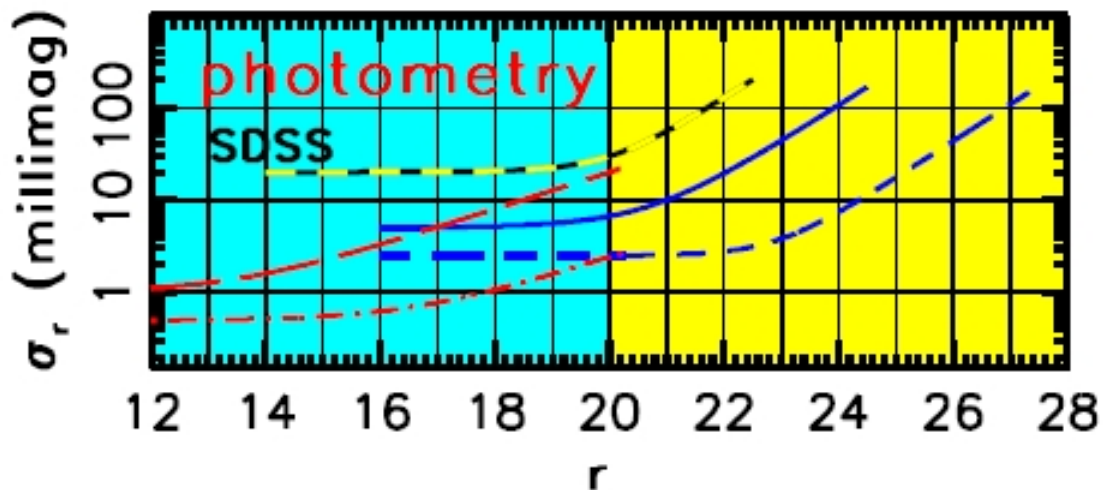

Gaia vs. LSST Comparison

- **Gaia:** excellent astrometry (and photometry), but only to $r < 20$
- **LSST:** photometry to $r < 27.5$ and time resolved measurements to $r < 24.5$
- **Complementarity** of the two surveys: photometric, proper motion and trigonometric parallax errors are similar around $r \sim 20$

The Milky Way disk “belongs” to Gaia, and the halo to LSST (plus very faint and/or very red sources, such as white dwarfs and LT(Y) dwarfs).

White Dwarfs with LSST

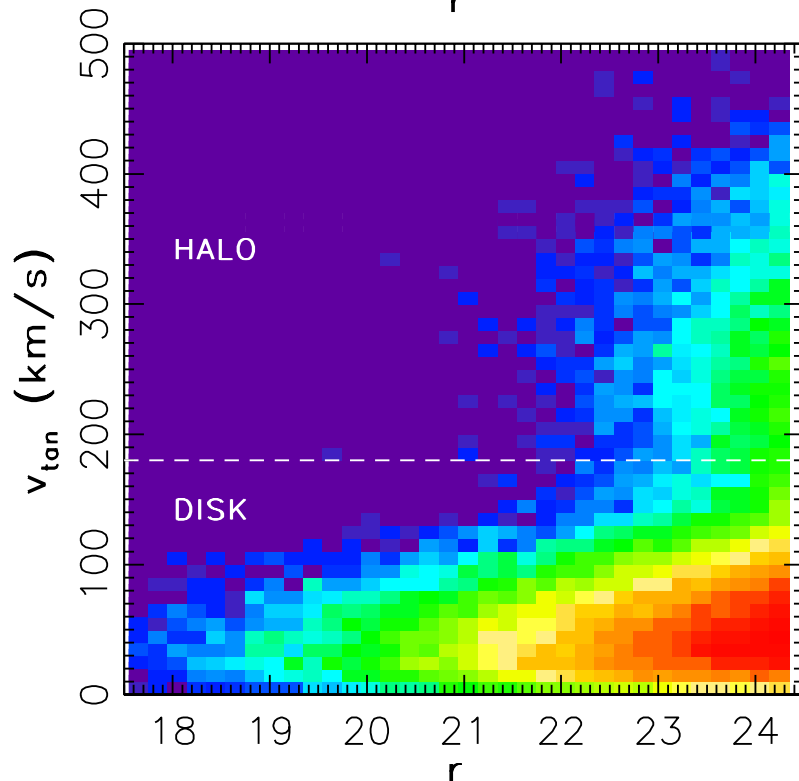
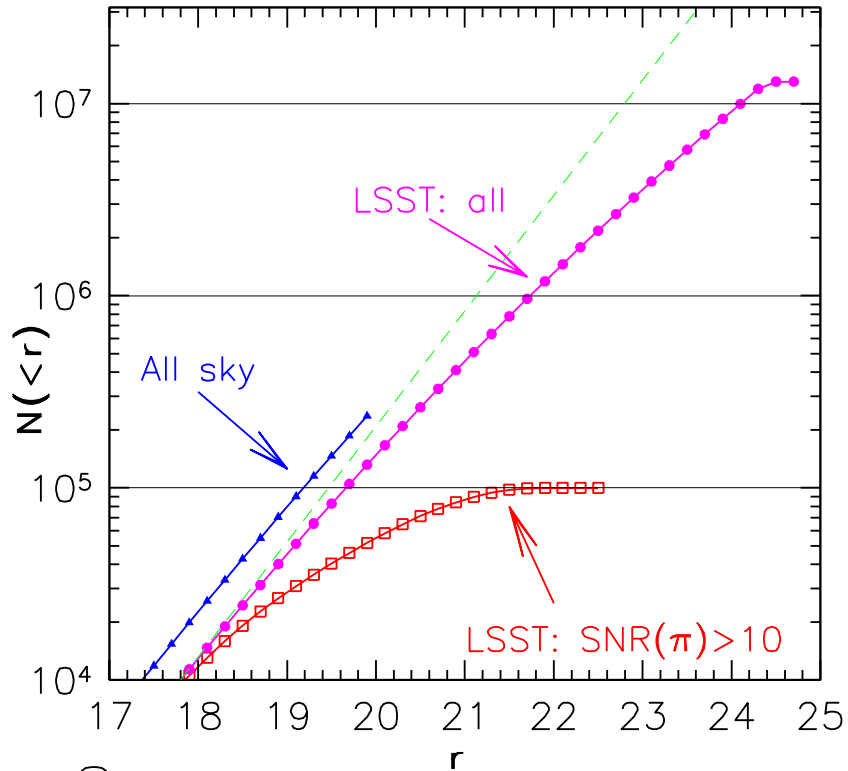

- **Top Left:** Counts of white dwarfs: about 300,000 detected by Gaia, over 10,000,000 for LSST with $r < 24.5$ (50 million for < 27.5)
- **Time resolved measurements** yield proper motion and trigonometric parallax; **coadded photometry** yields accurate colors (e.g. can photometrically separate H and He sequences, and estimate $\log(g)$ to 0.05 dex for some temperature intervals)
- **Bottom Left:** Disk and halo white dwarfs can be kinematically separated; there will be 400,000 halo white dwarfs in the LSST $r < 24.5$ sample (currently, fewer than 100 are known)
- **The white dwarfs luminosity function is sensitive to the population age; it will be measured separately for thin and thick disks, and halo**

Outer halo studies: RR Lyrae from SDSS Stripe 82

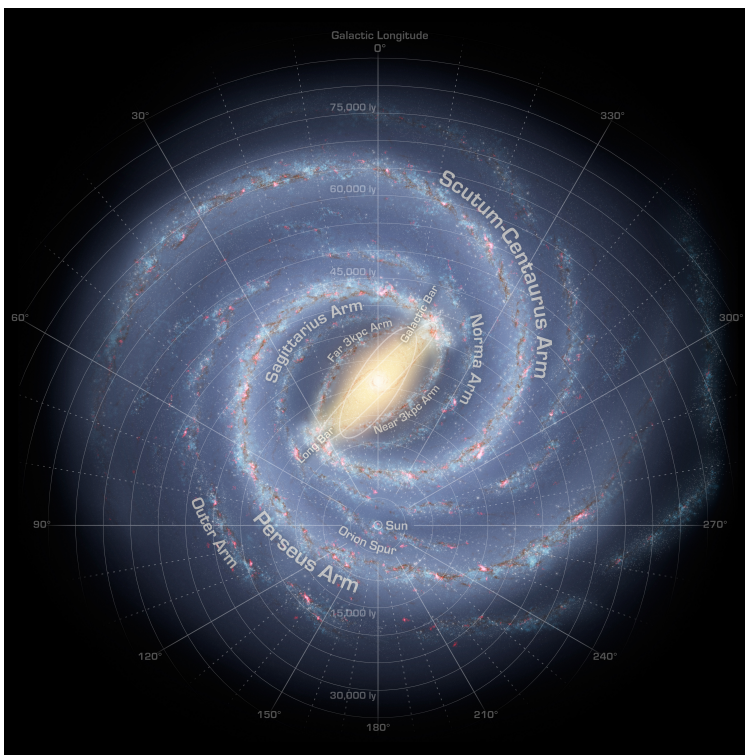

- **Top left:** the disk structure (artist's conception based on the Spitzer and other surveys of the Galactic plane)
- **Bottom left:** the halo density (multiplied by R^3 ; yellow and red are overdensities relative to mean $\rho(R) \propto R^{-3}$ density) as traced by RR Lyrae from SDSS Stripe 82 (Sesar et al. 2010), compared in scale to the top panel
- **Conclusions:** the spatial distribution of halo stars is highly inhomogeneous (clumpy); when averaged, the stellar volume density decreases as $\rho(R) \propto R^{-3}$.

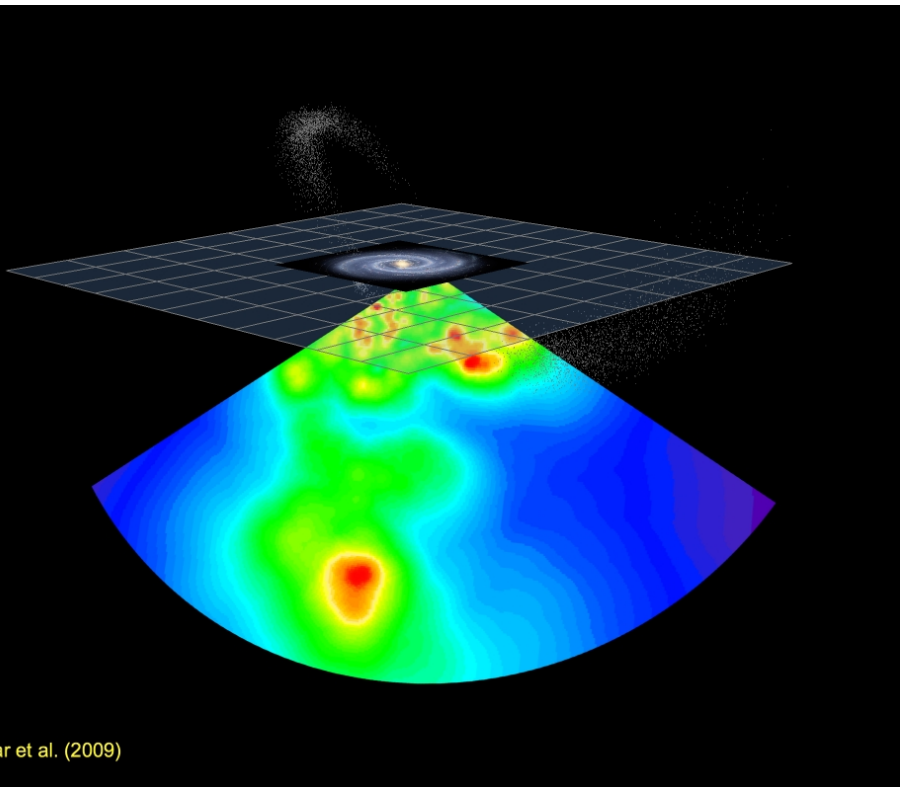

Outer halo studies: RR Lyrae from SDSS Stripe 82

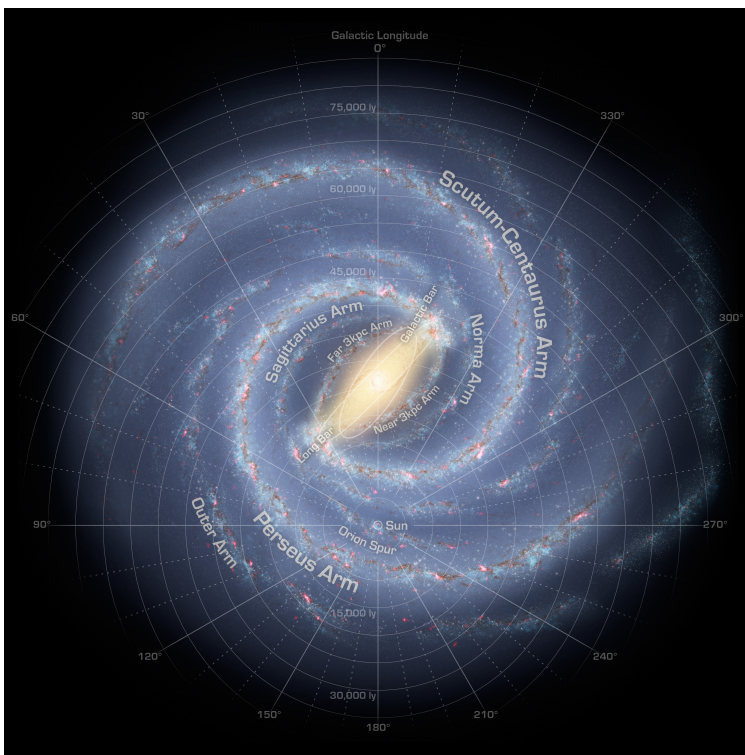

- **Top left:** the disk structure (artist's conception based on the Spitzer and other surveys of the Galactic plane)
- **Bottom left:** the halo density (multiplied by R^3 ; yellow and red are overdensities relative to mean $\rho(R) \propto R^{-3}$ density) as traced by RR Lyrae from SDSS Stripe 82 (Sesar et al. 2010), compared in scale to the top panel
- **Conclusions:** the spatial distribution of halo stars is highly inhomogeneous (clumpy); when averaged, the stellar volume density decreases as $\rho(R) \propto R^{-3}$. **Limited by data!**

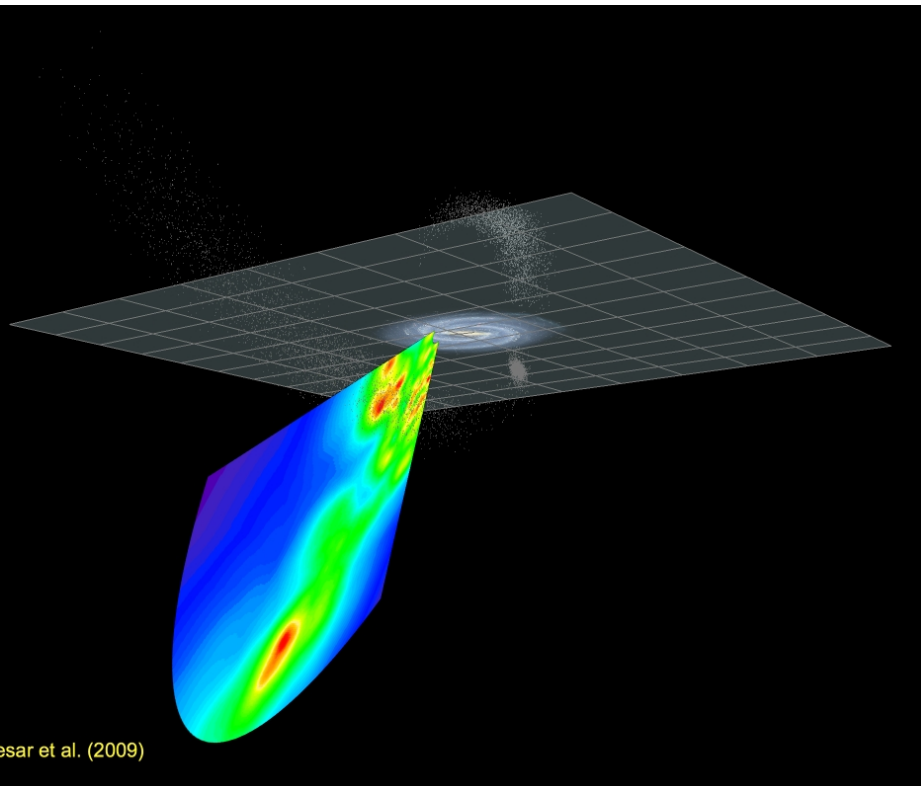

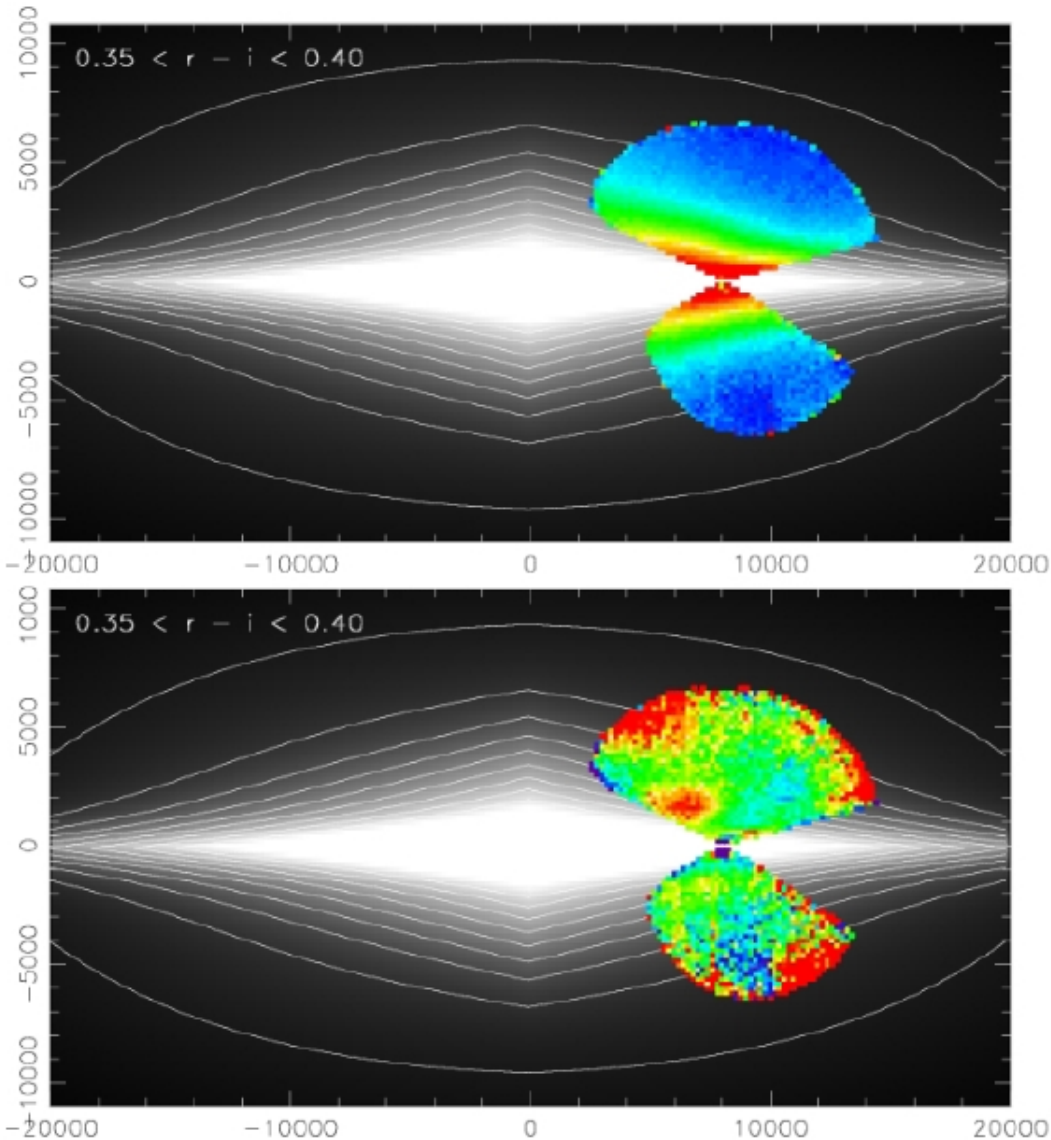

The limitations of SDSS data

- **Sky Coverage:** SDSS $\sim 1/4$ of the sky, **LSST** over $1/2$
- **Depth:** SDSS main-sequence stars to ~ 10 kpc; RR Lyrae stars to 100 kpc; **LSST** to 100 kpc and 400 kpc, respectively
- **Photometric Accuracy:** SDSS: photometric metallicity accurate to ~ 0.2 dex; **LSST** better than 0.1 dex
- **Astrometric Accuracy:** SDSS: proper motion accurate to 3 mas/yr; **with LSST** 0.2 mas/yr

The large blue circle: the ~ 400 kpc limit of future LSST studies based on RR Lyrae

The large red circle: the ~ 100 kpc limit of future LSST studies based on main-sequence stars (and the current limit for RR Lyrae studies)

LSST limit for RR Lyrae: 400 kpc

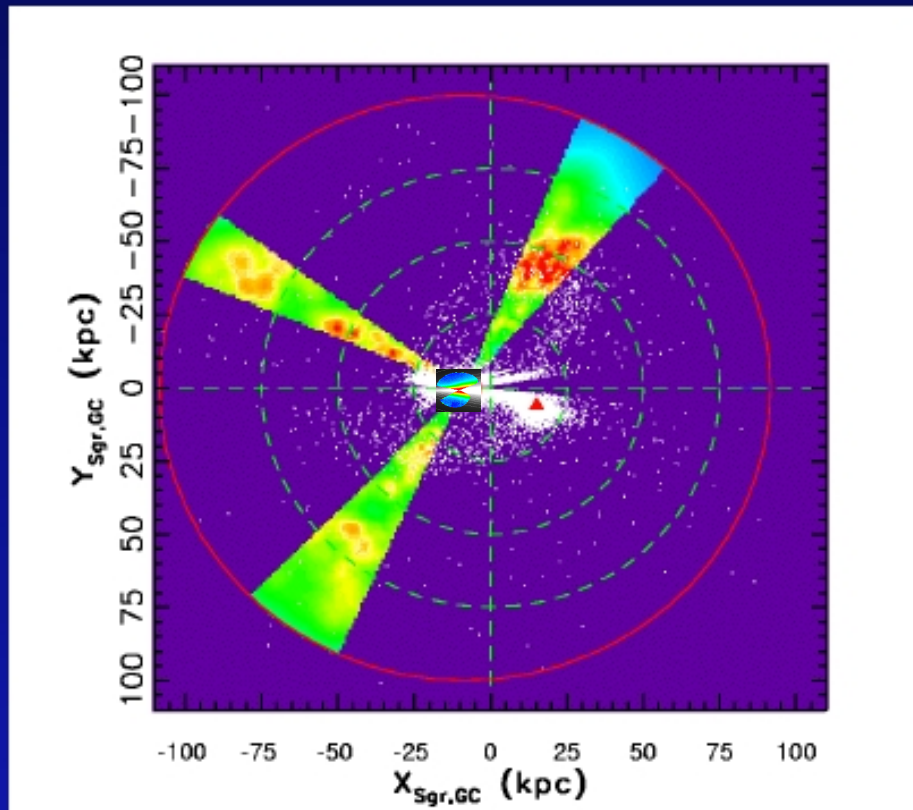

The small insert:
 ~ 10 kpc limit of SDSS and future Gaia studies for kinematic & $[Fe/H]$ mapping with MS stars

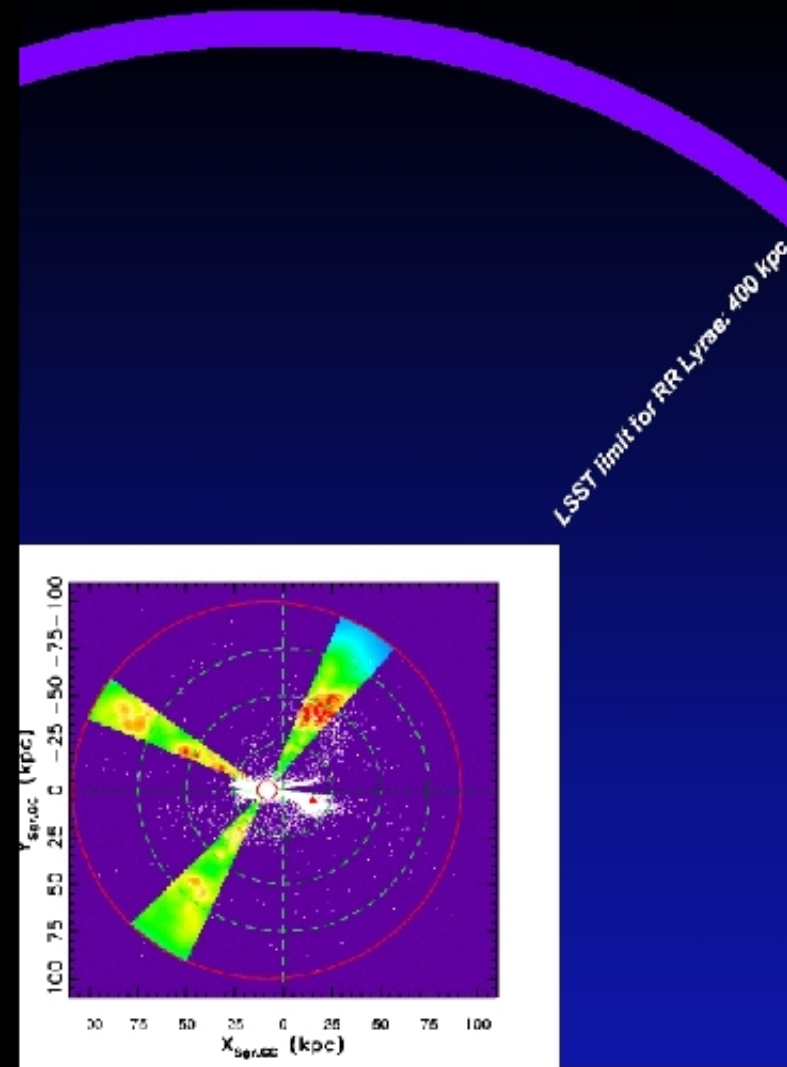
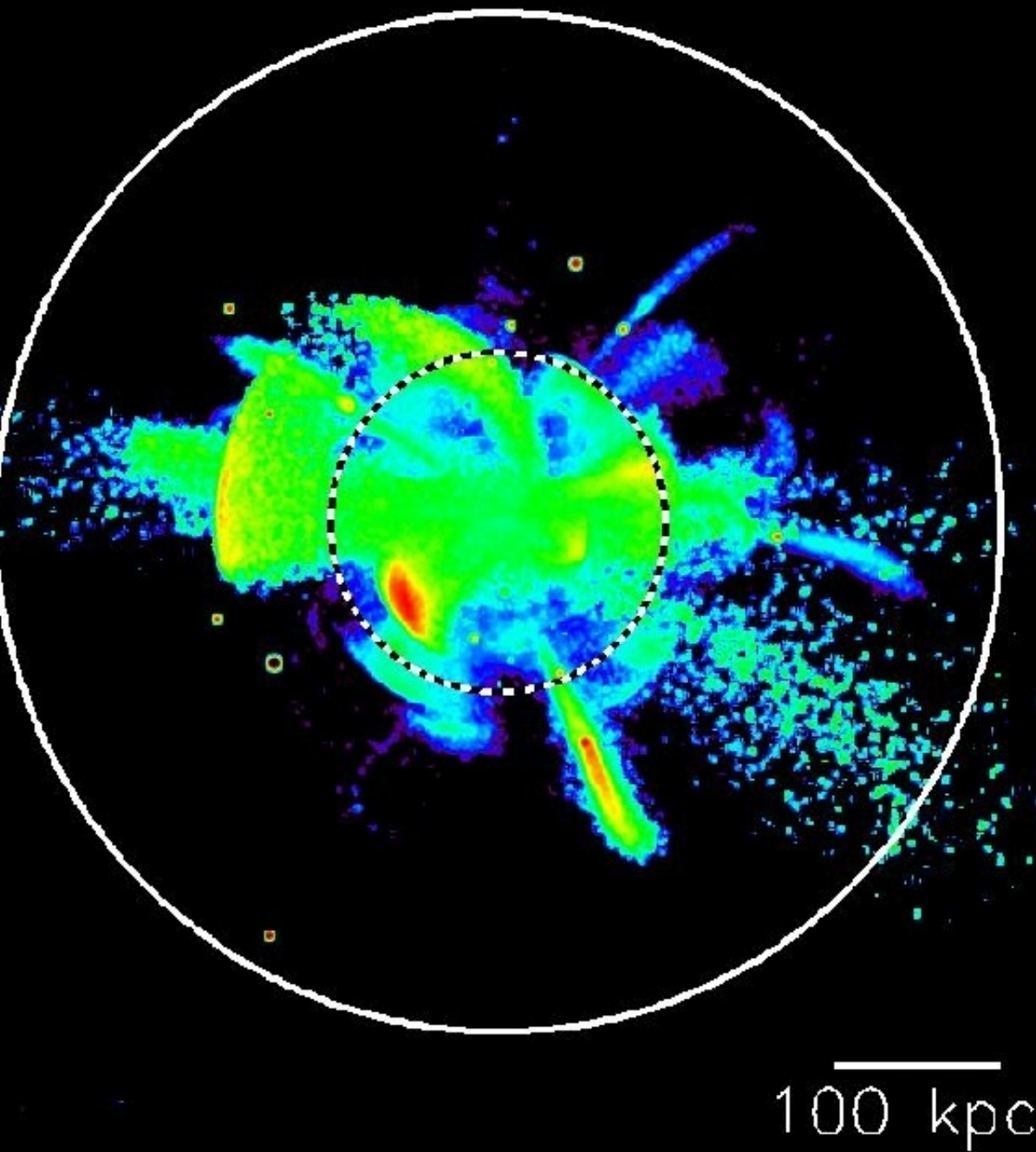

Left: Models (Bullock & Johnston) **Right:** SDSS and 2MASS observations, and predictions for LSST

The Excitement of LSST

- **The Best Sky Image Ever:** 60 petabytes of astronomical image data (resolution equal to 3 million HDTV sets)
- **The Greatest Movie of All Time:** digital images of the entire observable sky every three nights, night after night, for 10 years (11 months to “view” it)
- **The Largest Astronomical Catalog:** 20 billion sources (for the first time in history more than living people)

LSST data will tell us whether the recent cosmological acceleration is due to dark energy or modified gravity.

But the total impact of LSST may turn out to be much larger than that directly felt by the professional astronomy and physics communities: with an open 60 PB large database that is available in real-time to the public at large, LSST will bring the Universe home to everyone.

For more details:

LSST Science Book (www.lsst.org)

LSST overview paper ([arXiv:0805.2366](https://arxiv.org/abs/0805.2366))